

# PROFORM

CONFERENCE | TASK







Proform Model: 172-9C-95A-17PB



*It's more than just a chair.®*

# PROFORM

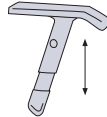
## PLANNING GUIDE

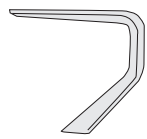
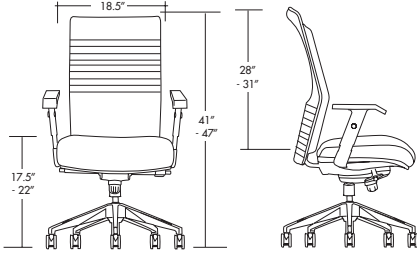
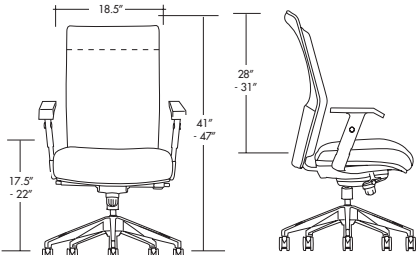
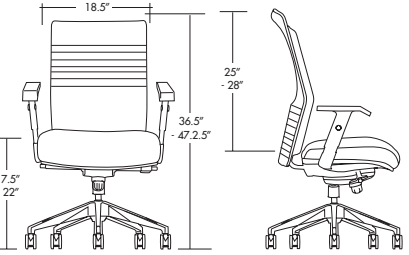
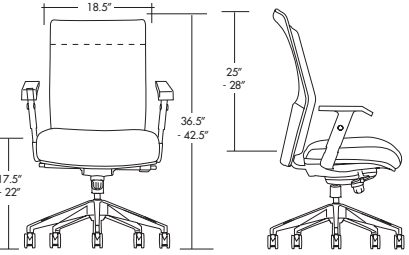
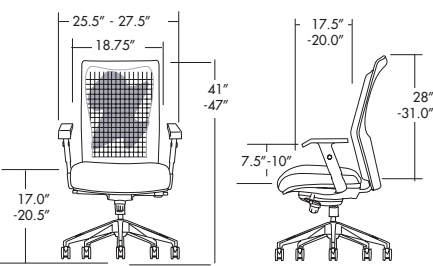
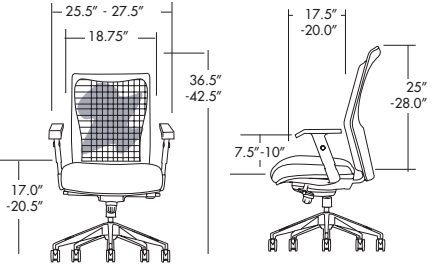
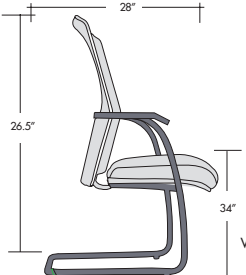
<p style="writing-mode: vertical-rl; transform: rotate(180deg);">STITCHING</p>	 <p>Parallel Stitching</p>	 <p>Panel Stitching</p>	<h3>ARM STYLES</h3>  <p>-50A11 ● Height Adjustable Arm</p>  <p>-65A ● Poly Loop Arm</p>  <p>-70A ● Alum Loop -71A ● Alum Loop - Uph</p>  <p>-95A ● Alum Exec 'C' Arm</p>
<p style="writing-mode: vertical-rl; transform: rotate(180deg);">HIGH BACK</p>	 <p>Seat - COM .75 yd.; COL 8.0 sq. ft.</p>	 <p>Seat - COM .75 yd.; COL 8.0 sq. ft.</p>	
<p style="writing-mode: vertical-rl; transform: rotate(180deg);">MID BACK</p>	 <p>Seat - COM .75 yd.; COL 8.0 sq. ft.</p>	 <p>Seat - COM .75 yd.; COL 8.0 sq. ft.</p>	
<p style="writing-mode: vertical-rl; transform: rotate(180deg);">HIGH BACK MESH</p>		<h3>CONSTRUCTION</h3> <p><b>Upholstery Platform:</b> Kiln-dried, laminated hardwood that incorporates compound curve design and "T-nut" connection hardware.</p> <p><b>Foam:</b> High density, cold cured, molded, CFC-free, polyurethane foam manufactured specially for VIA using a proprietary formula to give our chairs that special initial feel and long lasting comfort.</p> <p><b>Connection Hardware:</b> Inserted into the upholstery platforms are durable metal-to-metal "T-nut" connectors.</p> <p><b>Arms:</b> Two arm styles are available.</p> <p><b>Controls:</b> Heavy duty adjustment control mechanism is available - see pricing pages for details.</p> <p><b>Base:</b> The standard base is five-star, glass filled nylon. Optional metal, sled and wood bases are available - see pricing pages.</p> <p><b>Casters:</b> The standard casters installed on our chairs are hooded 55mm, heavy duty, twin-wheeled, carpet casters. Optional casters for hard surfaces and stationary applications are available - see pricing pages.</p> <p><b>Testing:</b> All chairs have been tested to comply with, and in many cases exceed, ANSI/BIFMA standards.</p>	
<p style="writing-mode: vertical-rl; transform: rotate(180deg);">MID BACK MESH</p>			
<p style="writing-mode: vertical-rl; transform: rotate(180deg);">GUEST CHAIR</p>	 <p>-24SB Sled Frame Weight capacity 300 lbs. 7 Arm Cap - Standard.</p>		

# PROFORM HIGH BACK / MEDIUM SEAT CONFERENCE

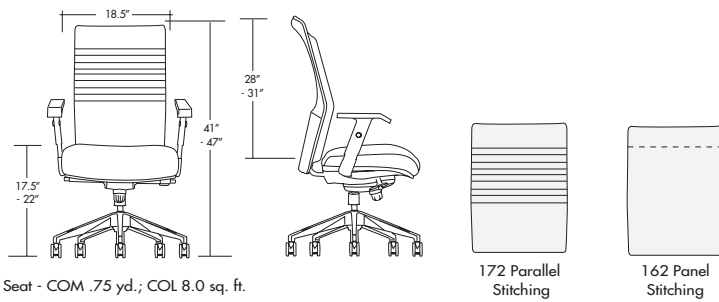

Seat - COM .75 yd.; COL 8.0 sq. ft.

172 Parallel  
Stitching

162 Panel  
Stitching

True 48-Hour Commitment

- **20/48** 20 Chairs Every 48 Hours
- **10/48** 10 Chairs Every 48 Hours

## HIGH BACK / MEDIUM SEAT - *Single Position Knee Tilt Control* (WEIGHT CAPACITY 300 LBS)

MODEL	CONTROL	ARM	QS	DESCRIPTION (SEE BELOW)	A	B	1/COM	2	3/COL	4	5	6	7	8
172				Parallel Stitching										
162				Panel Stitching										
	-12C	-0A	●	No Arms	781	809	866	908	978	1062	1160	1287	1441	1638
		-50A11	●	Height Adjustable Arm	859	887	944	986	1056	1140	1238	1365	1519	1716
		-65A	●	Poly Loop Arm	885	913	970	1012	1082	1166	1264	1391	1545	1742
		-70A	●	Alum Loop	958	986	1043	1085	1155	1239	1337	1464	1618	1815
		-95A	●	Alum Exec 'C'	989	1017	1074	1116	1186	1270	1368	1495	1649	1846
		-71A	○	Alum Loop - Uph	1061	1092	1155	1202	1280	1373	1482	1623	1794	2013

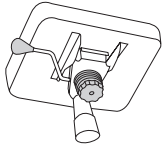

## HIGH BACK / MEDIUM SEAT- *Syncro Control* (WEIGHT CAPACITY 300 LBS)

MODEL	CONTROL	ARM	QS	DESCRIPTION (SEE BELOW)	A	B	1/COM	2	3/COL	4	5	6	7	8
172				Parallel Stitching										
162				Panel Stitching										
	-60C	-0A	●	No Arms	781	809	866	908	978	1062	1160	1287	1441	1638
		-50A11	●	Height Adjustable Arm	859	887	944	986	1056	1140	1238	1365	1519	1716
		-65A	●	Poly Loop Arm	885	913	970	1012	1082	1166	1264	1391	1545	1742
		-70A	●	Alum Loop	958	986	1043	1085	1155	1239	1337	1464	1618	1815
		-95A	●	Alum Exec 'C'	989	1017	1074	1116	1186	1270	1368	1495	1649	1846
		-71A	○	Alum Loop - Uph	1061	1092	1155	1202	1280	1373	1482	1623	1794	2013

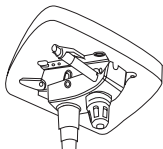

## HIGH BACK / MEDIUM SEAT- *Syncro Control with Side Tension Adjustment* (WEIGHT CAPACITY 300 LBS)

MODEL	CONTROL	ARM	QS	DESCRIPTION (SEE BELOW)	A	B	1/COM	2	3/COL	4	5	6	7	8
172				Parallel Stitching										
162				Panel Stitching										
	-9C	-0A	●	No Arms	833	861	918	960	1030	1114	1212	1339	1493	1690
		-50A11	●	Height Adjustable Arm	911	939	996	1038	1108	1192	1290	1417	1571	1768
		-65A	●	Poly Loop Arm	937	965	1022	1064	1134	1218	1316	1443	1597	1794
		-70A	●	Alum Loop	1010	1038	1095	1137	1207	1291	1389	1516	1670	1867
		-95A	●	Alum Exec 'C'	1041	1069	1126	1168	1238	1322	1420	1547	1701	1898
		-71A	○	Alum Loop - Uph	1113	1144	1207	1254	1332	1425	1534	1675	1846	2065

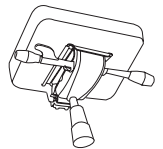

## STANDARD ARM OPTIONS

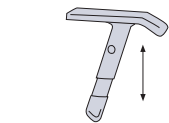

-50A11 ● Height Adjustable Arm



-65A ● Poly Loop Arm



-70A ● Alum Loop  
-71A ○ Alum Loop - Uph

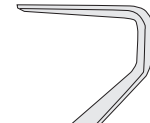

-95A ● Alum Exec 'C' Arm

How to Specify:  
**172-60C-50A11-17PB**  
SEAT & BACK CONTROL | ARM STYLE OPTION

## STANDARD CHAIR OPTIONS

SUFFIX	QS	DESCRIPTION	PRICE
-16SC	●	Hard Floor Casters	\$23 List
-9	●	Four Way Adjustable Arm Cap (50A only)	\$31 List
-15AB	●	Width Adjustable Bracket (50A only)	\$23 List
-30SS	●	Seat Slide (-60C, -9C)	\$73 List
-16GL	●	Glides	\$23 List

SUFFIX	QS	DESCRIPTION	PRICE
-17PB	●	High Profile Polished Aluminum Base	\$73 List
-21TB133	○	Fire Rated Products (See page 11)	\$159 List

# PROFORM

## MID BACK / MEDIUM SEAT

### CONFERENCE/TASK

True 48-Hour Commitment

- **20/48** 20 Chairs Every 48 Hours
- **10/48** 10 Chairs Every 48 Hours

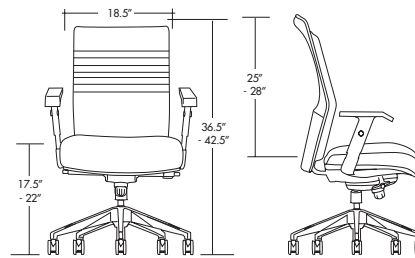

Seat - COM .75 yd.; COL 8.0 sq. ft.

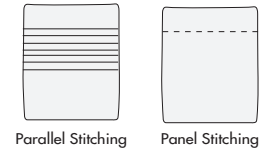

## MID BACK / MEDIUM SEAT - *Knee Tilt Control* (WEIGHT CAPACITY 300 LBS)

MODEL	CONTROL	ARM	QS	DESCRIPTION (SEE BELOW)	A	B	1/COM	2	3/COL	4	5	6	7	8
171				Parallel Stitching										
161				Panel Stitching										
	-12C	-0A	●	No Arms	736	761	811	849	911	986	1073	1186	1323	1498
		-50A11	●	Height Adjustable Arm	814	839	889	927	989	1064	1151	1264	1401	1576
		-65A	●	Poly Loop Arm	840	865	915	953	1015	1090	1177	1290	1427	1602
		-70A	●	Alum Loop	913	938	988	1026	1088	1163	1250	1363	1500	1675
		-95A	●	Alum Exec 'C'	944	969	1019	1057	1119	1194	1281	1394	1531	1706
		-71A	○	Alum Loop - Uph	1016	1044	1100	1143	1213	1297	1395	1522	1676	1873

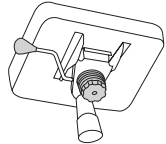

## MID BACK / MEDIUM SEAT - *Syncro Control* (WEIGHT CAPACITY 300 LBS)

MODEL	CONTROL	ARM	QS	DESCRIPTION (SEE BELOW)	A	B	1/COM	2	3/COL	4	5	6	7	8
171				Parallel Stitching										
161				Panel Stitching										
	-60C	-0A	●	No Arms	736	761	811	849	911	986	1073	1186	1323	1498
		-50A11	●	Height Adjustable Arm	814	839	889	927	989	1064	1151	1264	1401	1576
		-65A	●	Poly Loop Arm	840	865	915	953	1015	1090	1177	1290	1427	1602
		-70A	●	Alum Loop	913	938	988	1026	1088	1163	1250	1363	1500	1675
		-95A	●	Alum Exec 'C'	944	969	1019	1057	1119	1194	1281	1394	1531	1706
		-71A	○	Alum Loop - Uph	1016	1044	1100	1143	1213	1297	1395	1522	1676	1873

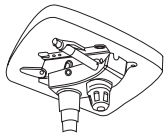

## MID BACK / MEDIUM SEAT - *Syncro Control with Side Tension Adjustment* (WEIGHT CAPACITY 300 LBS)

MODEL	CONTROL	ARM	QS	DESCRIPTION (SEE BELOW)	A	B	1/COM	2	3/COL	4	5	6	7	8
171				Parallel Stitching										
161				Panel Stitching										
	-9C	-0A	●	No Arms	788	813	863	901	963	1038	1125	1238	1375	1550
		-50A11	●	Height Adjustable Arm	866	891	941	979	1041	1116	1203	1316	1453	1628
		-65A	●	Poly Loop Arm	892	917	967	1005	1067	1142	1229	1342	1479	1654
		-70A	●	Alum Loop	965	990	1040	1078	1140	1215	1302	1415	1552	1727
		-95A	●	Alum Exec 'C'	996	1021	1071	1109	1171	1246	1333	1446	1583	1758
		-71A	○	Alum Loop - Uph	1068	1096	1152	1195	1265	1349	1447	1574	1728	1925

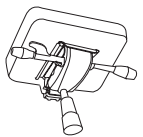

## STANDARD ARM OPTIONS



How to Specify:

**171-60C-50A11-17PB**  
SEAT & BACK CONTROL | ARM STYLE OPTION

## STANDARD CHAIR OPTIONS

SUFFIX	QS	DESCRIPTION	PRICE	SUFFIX	QS	DESCRIPTION	PRICE
-165C	●	Hard Floor Casters	\$23 List	-17PB	●	High Profile Polished Aluminum Base	\$73 List
-9	●	Four Way Adjustable Arm Cap (50A only)	\$31 List	-21TB133	○	Fire Rated Products (See page 11)	\$159 List
-15AB	●	Width Adjustable Bracket (50A only)	\$23 List				
-30SS	●	Seat Slide (-60C, -9C)	\$73 List				
-16GL	●	Glides	\$23 List				



# PROFORM

## HIGH BACK MESH / MEDIUM SEAT

### CONFERENCE/TASK

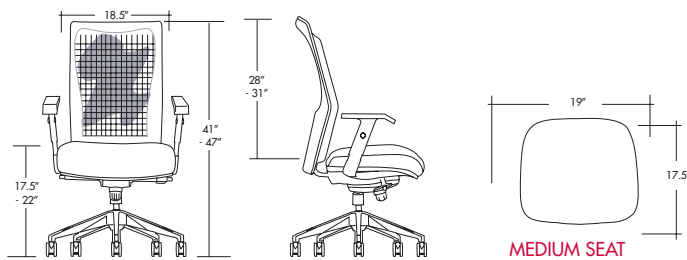

Seat - COM .75 yd.; COL 8.0 sq. ft.

True 48-Hour Commitment

- **20/48** 20 Chairs Every 48 Hours
- **10/48** 10 Chairs Every 48 Hours

#### HIGH BACK MESH/ MEDIUM SEAT - *Single Position Knee Tilt Control* (WEIGHT CAPACITY 300 LBS)

MODEL	CONTROL	ARM	QS	DESCRIPTION (SEE BELOW)	A	B	1/COM	2	3/COL	4	5	6	7	8
152	-12C	-0A	●	No Arms	606	615	634	648	671	699	732	774	826	891
		-50A11	●	Height Adjustable Arm	684	693	712	726	749	777	810	852	904	969
		-65A	●	Poly Loop Arm	710	719	738	752	775	803	836	878	930	995
		-70A	●	Alum Loop	783	792	811	825	848	876	909	951	1003	1068
		-95A	●	Alum Exec 'C'	814	823	842	856	879	907	940	982	1034	1099
		-71A	○	Alum Loop - Uph	886	898	923	942	973	1010	1054	1110	1179	1266

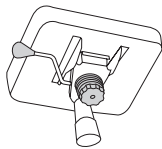

#### HIGH BACK MESH / MEDIUM SEAT- *Syncro Control* (WEIGHT CAPACITY 300 LBS)

MODEL	CONTROL	ARM	QS	DESCRIPTION (SEE BELOW)	A	B	1/COM	2	3/COL	4	5	6	7	8
152	-60C	-0A	●	No Arms	606	615	634	648	671	699	732	774	826	891
		-50A11	●	Height Adjustable Arm	684	693	712	726	749	777	810	852	904	969
		-65A	●	Poly Loop Arm	710	719	738	752	775	803	836	878	930	995
		-70A	●	Alum Loop	783	792	811	825	848	876	909	951	1003	1068
		-95A	●	Alum Exec 'C'	814	823	842	856	879	907	940	982	1034	1099
		-71A	○	Alum Loop - Uph	886	898	923	942	973	1010	1054	1110	1179	1266

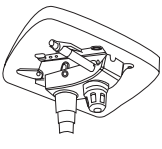

#### HIGH BACK MESH/ MEDIUM SEAT - *Syncro Control with Side Tension Adjustment* (WEIGHT CAPACITY 300 LBS)

MODEL	CONTROL	ARM	QS	DESCRIPTION (SEE BELOW)	A	B	1/COM	2	3/COL	4	5	6	7	8
152	-9C	-0A	●	No Arms	658	667	686	700	723	751	784	826	878	943
		-50A11	●	Height Adjustable Arm	736	745	764	778	801	829	862	904	956	1021
		-65A	●	Poly Loop Arm	762	771	790	804	827	855	888	930	982	1047
		-70A	●	Alum Loop	835	844	863	877	900	928	961	1003	1055	1120
		-95A	●	Alum Exec 'C'	866	875	894	908	931	959	992	1034	1086	1151
		-71A	○	Alum Loop - Uph	938	950	975	994	1025	1062	1106	1162	1231	1318

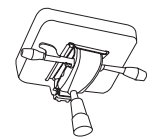

#### STANDARD ARM OPTIONS

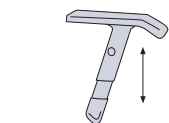

-50A11 ● Height Adjustable Arm



-65A ● Poly Loop Arm



-70A ● Alum Loop  
-71A ○ Alum Loop - Uph



-95A ● Alum Exec 'C' Arm

#### MESH COLORS AVAILABLE

SUFFIX	DESCRIPTION	PRICE
-01PHM	Black Mesh	\$0
-03PHM	Graphite Mesh	\$21
-05PHM	Doe Mesh	\$21
-07PHM	Sea Foam Mesh	\$21

#### STANDARD CHAIR OPTIONS

SUFFIX	QS	DESCRIPTION	PRICE
-16SC	●	Hard Floor Casters	\$23 List
-9	●	Four Way Adjustable Arm Cap (50A only)	\$31 List
-15AB	●	Width Adjustable Bracket (50A only)	\$23 List
-30SS	●	Seat Slide (-60C, -9C)	\$73 List
-16GL	●	Glides	\$23 List

SUFFIX	QS	DESCRIPTION	PRICE
-17PB	●	High Profile Polished Aluminum Base	\$73 List
-21TB133	○	Fire Rated Products (See page 11)	\$92 List

# PROFORM

## MID BACK MESH / MEDIUM SEAT

### CONFERENCE/TASK

True 48-Hour Commitment

- **20/48** 20 Chairs Every 48 Hours
- **10/48** 10 Chairs Every 48 Hours

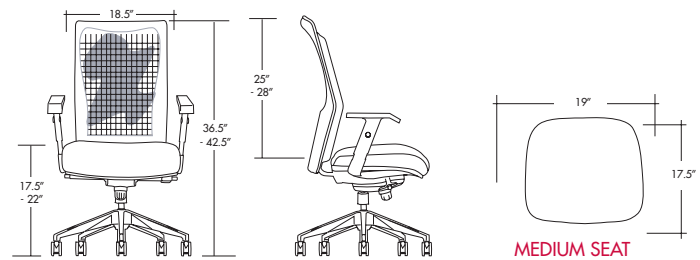

Seat - COM .75 yd.; COL 8.0 sq. ft.

### MID BACK / MEDIUM SEAT - *Single Position Knee Tilt Control* (WEIGHT CAPACITY 300 LBS)

MODEL	CONTROL	ARM	QS	DESCRIPTION (SEE BELOW)	A	B	1/COM	2	3/COL	4	5	6	7	8
151	-12C	-0A	●	No Arms	586	595	614	628	651	679	712	754	806	871
		-50A11	●	Height Adjustable Arm	664	673	692	706	729	757	790	832	884	949
		-65A	●	Poly Loop Arm	690	699	718	732	755	783	816	858	910	975
		-70A	●	Alum Loop	763	772	791	805	828	856	889	931	983	1048
		-95A	●	Alum Exec 'C'	794	803	822	836	859	887	920	962	1014	1079
		-71A	○	Alum Loop - Uph	866	878	903	922	953	990	1034	1090	1159	1246

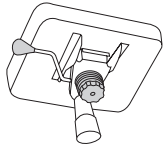

### MID BACK / MEDIUM SEAT- *Syncro Control* (WEIGHT CAPACITY 300 LBS)

MODEL	CONTROL	ARM	QS	DESCRIPTION (SEE BELOW)	A	B	1/COM	2	3/COL	4	5	6	7	8
151	-60C	-0A	●	No Arms	586	595	614	628	651	679	712	754	806	871
		-50A11	●	Height Adjustable Arm	664	673	692	706	729	757	790	832	884	949
		-65A	●	Poly Loop Arm	690	699	718	732	755	783	816	858	910	975
		-70A	●	Alum Loop	763	772	791	805	828	856	889	931	983	1048
		-95A	●	Alum Exec 'C'	794	803	822	836	859	887	920	962	1014	1079
		-71A	○	Alum Loop - Uph	866	878	903	922	953	990	1034	1090	1159	1246

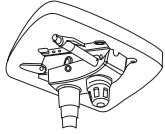

### MID BACK MESH / MEDIUM SEAT - *Syncro Control with Side Tension Adjustment* (WEIGHT CAPACITY 300 LBS)

MODEL	CONTROL	ARM	QS	DESCRIPTION (SEE BELOW)	A	B	1/COM	2	3/COL	4	5	6	7	8
151	-9C	-0A	●	No Arms	638	647	666	680	703	731	764	806	858	923
		-50A11	●	Height Adjustable Arm	716	725	744	758	781	809	842	884	936	1001
		-65A	●	Poly Loop Arm	742	751	770	784	807	835	868	910	962	1027
		-70A	●	Alum Loop	815	824	843	857	880	908	941	983	1035	1100
		-95A	●	Alum Exec 'C'	846	855	874	888	911	939	972	1014	1066	1131
		-71A	○	Alum Loop - Uph	918	930	955	974	1005	1042	1086	1142	1211	1298

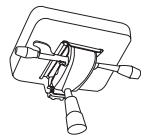

### STANDARD ARM OPTIONS

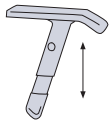

-50A11 ● Height Adjustable Arm



-65A ● Poly Loop Arm



-70A ● Alum Loop  
-71A ○ Alum Loop - Uph



-95A ● Alum Exec 'C' Arm

### MESH COLORS AVAILABLE

SUFFIX	DESCRIPTION	PRICE
-01PMM	Black Mesh	\$0
-03PMM	Graphite Mesh	\$21
-05PMM	Doe Mesh	\$21
-07PMM	Sea Foam Mesh	\$21

### STANDARD CHAIR OPTIONS

SUFFIX	QS	DESCRIPTION	PRICE	SUFFIX	QS	DESCRIPTION	PRICE
-16SC	●	Hard Floor Casters	\$23 List	-17PB	●	High Profile Polished Aluminum Base	\$73 List
-9	●	Four Way Adjustable Arm Cap (50A only)	\$31 List	-21TB133	○	Fire Rated Products (See page 11)	\$92 List
-15AB	●	Width Adjustable Bracket (50A only)	\$23 List				
-30SS	●	Seat Slide (-60C, -9C)	\$73 List				
-16GL	●	Glides	\$23 List				

# PROFORM GUEST CHAIR

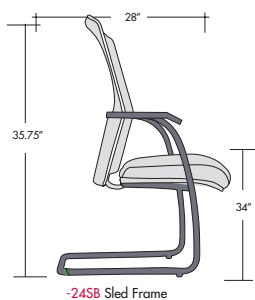

## True 48-Hour Commitment

- **20/48** 20 Chairs Every 48 Hours
- **10/48** 10 Chairs Every 48 Hours

### GUEST CHAIR - *Sled Frame and Four Leg Frame* (WEIGHT CAPACITY 300 LBS)

MODEL	CONTROL	ARM	QS	DESCRIPTION (SEE BELOW)	A	B	1/COM	2	3/COL	4	5	6	7	8
171	-24SB		●	Parallel Black Sled Frame	838	863	913	951	1013	1088	1175	1288	1425	1600
171	-24CR		●	Parallel Chrome Sled Frame	875	900	950	988	1050	1125	1212	1325	1462	1637
161	-24SB		●	Panel Black Sled Frame	838	863	913	951	1013	1088	1175	1288	1425	1600
161	-24CR		●	Panel Chrome Sled Frame	875	900	950	988	1050	1125	1212	1325	1462	1637
151	-24SB		●	Mesh Black Sled Frame	688	697	716	730	753	781	814	856	908	973
151	-24CR		●	Mesh Chrome Sled Frame	725	734	753	767	790	818	851	893	945	1010

### MESH COLORS AVAILABLE

SUFFIX	DESCRIPTION	PRICE
-01PMM	Black Mesh	\$0
-03PMM	Graphite Mesh	\$21
-05PMM	Doe Mesh	\$21
-07PMM	Sea Foam Mesh	\$21

### STANDARD CHAIR OPTIONS

SUFFIX	QS	DESCRIPTION	PRICE
-21TB133	●	Fire Rated Products (See page 11)	\$92 List