

DUALITY

EXECUTIVE | CONFERENCE



Duality Model: 2105-9C-95A-17PB



It's more than just a chair.®

DUALITY

PLANNING GUIDE

SEAT SIZES

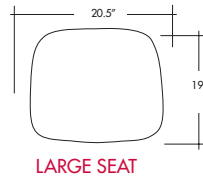
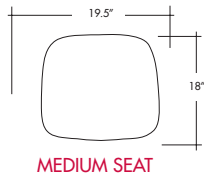

ARM STYLES

EXECUTIVE/CONFERENCE MID BACK

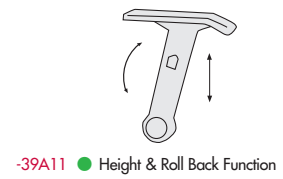
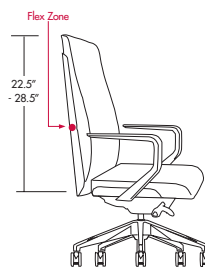
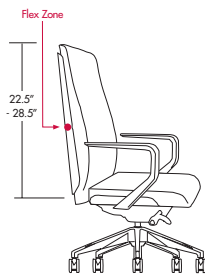
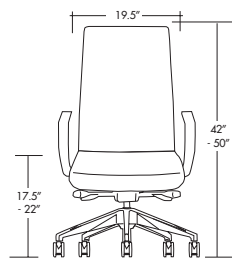
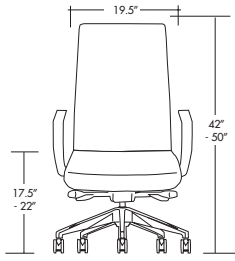

EXECUTIVE/CONFERENCE HIGH BACK

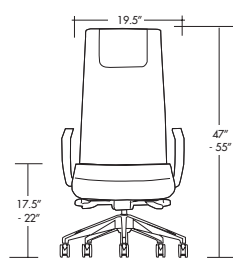
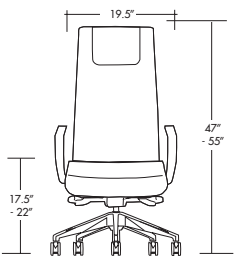

-71A ● Alum Loop - Uph

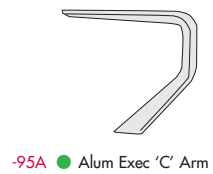
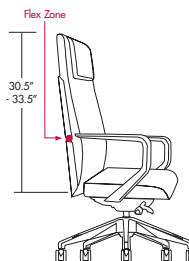
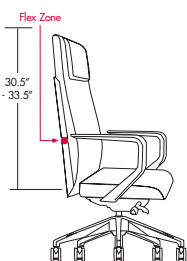

SEAT SIZES

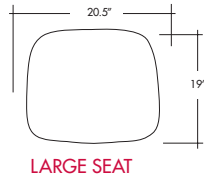
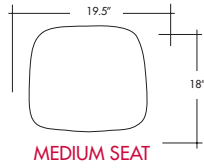

ARM STYLES

CONSTRUCTION

Seat Upholstery Platform: Kiln-dried, laminated hardwood that incorporates compound curve design and "T-nut" connection hardware. Injection molded plastic that incorporates a reinforced, compound curved design and "T-nut" connection hardware.

Outer Protective Shells: Durable, scuff resistant injection molded plastic that may be upholstered.

Foam: High density, cold cured, molded, CFC-free, polyurethane foam manufactured specially for VIA using a proprietary formula to give our chairs that special initial feel and long lasting comfort.

Connection Hardware: Inserted into the upholstery platforms are durable metal-to-metal "T-nut" connectors.

Arm Pads: Durable but supple self-skinned urethane.

Controls: Four adjustment control mechanisms are available - see pricing pages and pages 10-11 for details.

Base: The standard base is five-star, glass filled nylon. Optional metal and wood bases are available - see pricing pages.

Casters: The standard casters installed on our chairs are hooded 55mm, heavy duty, twin-wheeled, carpet casters. Optional casters for hard surfaces and stationary applications are available - see pricing pages.

Testing: All chairs have been tested to comply with, and in many cases exceed, ANSI/BIFMA standards.

TASK LOW BACK

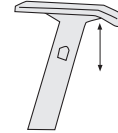
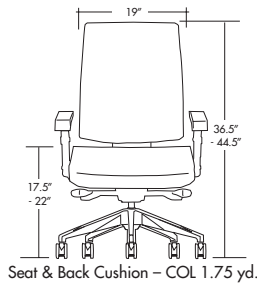
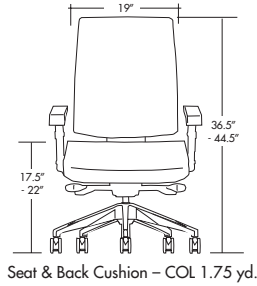

-38A11 ● Height Adjustable

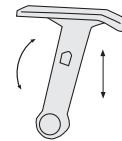

-39A11 ● Height & Roll Back Function

TASK MID BACK

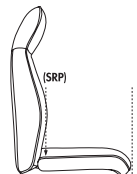
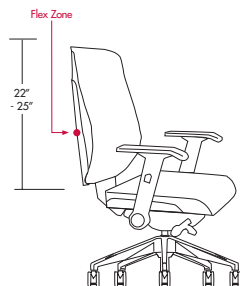
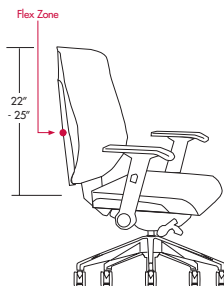
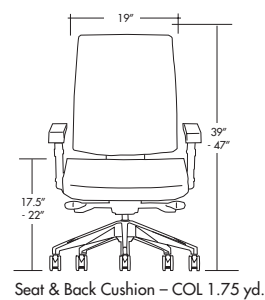
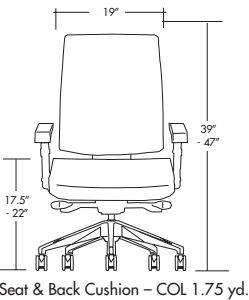

ACCORDING TO ANSI,
The seat reference point (SRP) is the distance from a slight indentation in the lumbar to the front of the seat.

DUALITY

HIGH BACK / LARGE SEAT

EXECUTIVE / CONFERENCE

True 48-Hour Commitment

● **20/48** 20 Chairs Every 48 Hours

○ **10/48** 10 Chairs Every 48 Hours

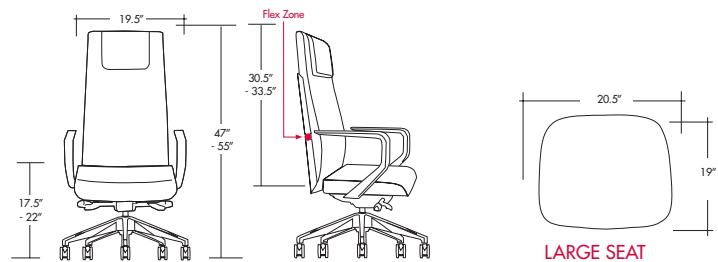

Seat & Back Cushion - COL 2.25 yd. Seat & Back Cushion - COM 2 yd.

HIGH BACK / LARGE SEAT - *Knee Tilt Control* (WEIGHT CAPACITY 300 LBS)

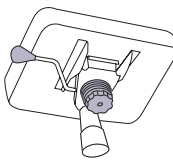
MODEL	CONTROL	ARM	QS	DESCRIPTION (SEE BELOW)	A	B	1/COM	2	3/COL	4	5	6	7	8
	2207	-12C	-38A11	● Height Adjustable	1017	1045	1102	1144	1214	1298	1396	1523	1677	1874
			-39A11	● Height and Roll Back Function	1043	1071	1128	1170	1240	1324	1422	1549	1703	1900
			-65A	● Poly Loop	1043	1071	1128	1170	1240	1324	1422	1549	1703	1900
			-70A	● Alum Loop	1116	1144	1201	1243	1313	1397	1495	1622	1776	1973
			-95A	● Alum Exec 'C'	1147	1175	1232	1274	1344	1428	1526	1653	1807	2004
			-71A	○ Alum Loop - Uph	1219	1250	1313	1360	1438	1531	1640	1781	1952	2171

HIGH BACK / LARGE SEAT - *Syncro Control* (WEIGHT CAPACITY 300 LBS)

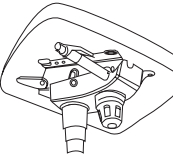
MODEL	CONTROL	ARM	QS	DESCRIPTION (SEE BELOW)	A	B	1/COM	2	3/COL	4	5	6	7	8
	2207	-60C	-38A11	● Height Adjustable	1017	1045	1102	1144	1214	1298	1396	1523	1677	1874
			-39A11	● Height and Roll Back Function	1043	1071	1128	1170	1240	1324	1422	1549	1703	1900
			-65A	● Poly Loop	1043	1071	1128	1170	1240	1324	1422	1549	1703	1900
			-70A	● Alum Loop	1116	1144	1201	1243	1313	1397	1495	1622	1776	1973
			-95A	● Alum Exec 'C'	1147	1175	1232	1274	1344	1428	1526	1653	1807	2004
			-71A	○ Alum Loop - Uph	1219	1250	1313	1360	1438	1531	1640	1781	1952	2171

HIGH BACK / LARGE SEAT - *Syncro Control with Side Tension Adjustment* (WEIGHT CAPACITY 300 LBS)

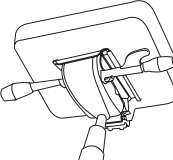
MODEL	CONTROL	ARM	QS	DESCRIPTION (SEE BELOW)	A	B	1/COM	2	3/COL	4	5	6	7	8
	2207	-9C	-38A11	● Height Adjustable	1069	1097	1154	1196	1266	1350	1448	1575	1729	1926
			-39A11	● Height Adj & Roll Back Function	1095	1123	1180	1222	1292	1376	1474	1601	1755	1952
			-65A	● Poly Loop	1095	1123	1180	1222	1292	1376	1474	1601	1755	1952
			-70A	● Alum Loop	1168	1196	1253	1295	1365	1449	1547	1674	1828	2025
			-95A	● Alum Exec 'C'	1199	1227	1284	1326	1396	1480	1578	1705	1859	2056
			-71A	○ Alum Loop - Uph	1271	1302	1365	1412	1490	1583	1692	1833	2004	2223

STANDARD ARM OPTIONS

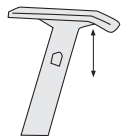

-38A11 ● Height Adjustable

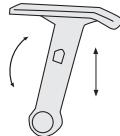

-39A11 ● Height & Roll Back Function



-65A ● Poly Loop Arm



-70A ● Alum Loop
-71A ● Alum Loop - Uph



-95A ● Alum Exec 'C' Arm

STANDARD CHAIR OPTIONS

SUFFIX	QS	DESCRIPTION	PRICE
-9	●	Four Way Adjustable Arm Cap (38A or 39A)	\$31 List
-3055	●	Seat Slide Option (-60C, -9C)	\$73 List
-165C	●	Hard Floor Casters	\$23 List
-16GL	●	Glides	\$23 List
-17PB	●	High Profile Polished Aluminum Base	\$73 List
-11CB	○	Custom Stain Base	\$223 List
-21TB133	○	Fire Rated Products	\$159 List

BACK AND SEAT SHELL COLOR OPTIONS

- 07B Black plastic set for mid back
- 07W White plastic set for mid back
- 07G Gray plastic set for mid back

No Charge
Upcharge - \$52 List
Upcharge - \$52 List

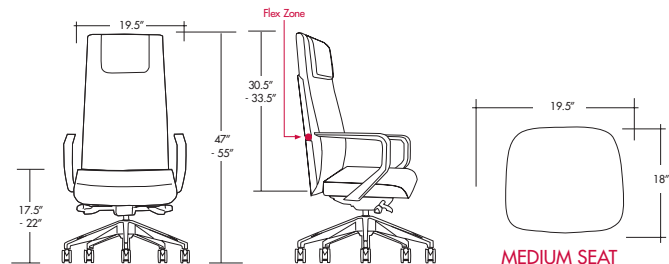

Seat & Back Cushion – COL 2.25 yd. Seat & Back Cushion – COM 2 yd.

DUALITY

HIGH BACK / MEDIUM SEAT

EXECUTIVE / CONFERENCE

True 48-Hour Commitment

- **20/48** 20 Chairs Every 48 Hours
- **10/48** 10 Chairs Every 48 Hours

HIGH BACK / MEDIUM SEAT - *Knee Tilt Control* (WEIGHT CAPACITY 300 LBS)

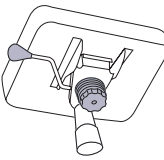
MODEL	CONTROL	ARM	QS	DESCRIPTION (SEE BELOW)	A	B	1/COM	2	3/COL	4	5	6	7	8
	2107	-12C	-38A11	● Height Adjustable	945	973	1030	1072	1142	1226	1324	1451	1605	1802
			-39A11	● Height and Roll Back Function	971	999	1056	1098	1168	1252	1350	1477	1631	1828
			-65A	● Poly Loop	971	999	1056	1098	1168	1252	1350	1477	1631	1828
			-70A	● Alum Loop	1043	1071	1128	1170	1240	1324	1422	1549	1703	1900
			-95A	● Alum Exec 'C'	1075	1103	1160	1202	1272	1356	1454	1581	1735	1932
			-71A	○ Alum Loop - Uph	1146	1177	1240	1287	1365	1458	1567	1708	1879	2098

HIGH BACK / MEDIUM SEAT - *Syncro Control* (WEIGHT CAPACITY 300 LBS)

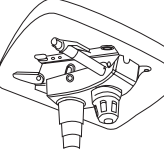
MODEL	CONTROL	ARM	QS	DESCRIPTION (SEE BELOW)	A	B	1/COM	2	3/COL	4	5	6	7	8
	2107	-60C	-38A11	● Height Adjustable	945	973	1030	1072	1142	1226	1324	1451	1605	1802
			-39A11	● Height and Roll Back Function	971	999	1056	1098	1168	1252	1350	1477	1631	1828
			-65A	● Poly Loop	971	999	1056	1098	1168	1252	1350	1477	1631	1828
			-70A	● Alum Loop	1043	1071	1128	1170	1240	1324	1422	1549	1703	1900
			-95A	● Alum Exec 'C'	1075	1103	1160	1202	1272	1356	1454	1581	1735	1932
			-71A	○ Alum Loop - Uph	1146	1177	1240	1287	1365	1458	1567	1708	1879	2098

HIGH BACK / MEDIUM SEAT - *Syncro Control with Side Tension Adjustment* (WEIGHT CAPACITY 300 LBS)

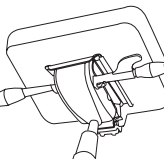
MODEL	CONTROL	ARM	QS	DESCRIPTION (SEE BELOW)	A	B	1/COM	2	3/COL	4	5	6	7	8
	2107	-9C	-38A11	● Height Adjustable	997	1025	1082	1124	1194	1278	1376	1503	1657	1854
			-39A11	● Height and Roll Back Function	1023	1051	1108	1150	1220	1304	1402	1529	1683	1880
			-65A	● Poly Loop	1023	1051	1108	1150	1220	1304	1402	1529	1683	1880
			-70A	● Alum Loop	1095	1123	1180	1222	1292	1376	1474	1601	1755	1952
			-95A	● Alum Exec 'C'	1127	1155	1212	1254	1324	1408	1506	1633	1787	1984
			-71A	○ Alum Loop - Uph	1198	1229	1292	1339	1417	1510	1619	1760	1931	2150

STANDARD ARM OPTIONS

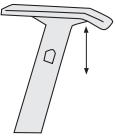

-38A11 ● Height Adjustable

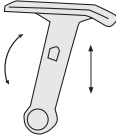

-39A11 ● Height & Roll Back Function



-65A ● Poly Loop Arm



-70A ● Alum Loop
-71A ○ Alum Loop - Uph

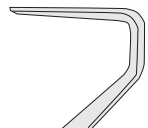

-95A ● Alum Exec 'C' Arm

STANDARD CHAIR OPTIONS

SUFFIX	QS	DESCRIPTION	PRICE
-9	●	Four Way Adjustable Arm Cap (38A or 39A)	\$31 List
-30SS	●	Seat Slide Option (-60C, -9C)	\$73 List
-16SC	●	Hard Floor Casters	\$23 List
-16GL	●	Glides	\$23 List
-17PB	●	High Profile Polished Aluminum Base	\$73 List
-11CB	○	Custom Stain Base	\$223 List
-21TB133	○	Fire Rated Products	\$159 List

BACK AND SEAT SHELL COLOR OPTIONS

-07B	Black plastic set for mid back	No Charge
-07W	White plastic set for mid back	Upcharge - \$52 List
-07G	Gray plastic set for mid back	Upcharge - \$52 List

DUALITY

MID BACK / LARGE SEAT

EXECUTIVE / CONFERENCE

True 48-Hour Commitment

● **20/48** 20 Chairs Every 48 Hours

○ **10/48** 10 Chairs Every 48 Hours

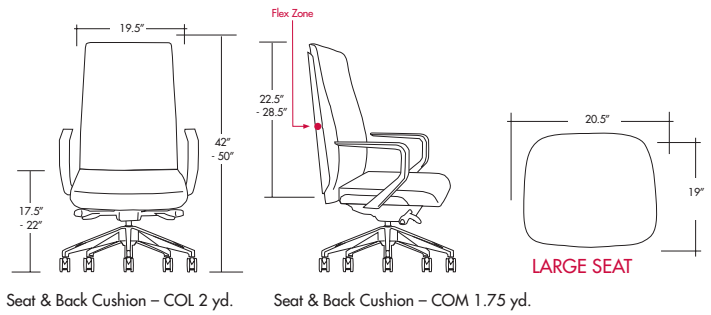

MID BACK / LARGE SEAT - *Knee Tilt Control* (WEIGHT CAPACITY 300 LBS)

MODEL	CONTROL	ARM	QS	DESCRIPTION (SEE BELOW)	A	B	1/COM	2	3/COL	4	5	6	7	8
2205	-12C	-0A	●	No Arms	851	876	926	964	1026	1101	1188	1301	1438	1613
		-38A11	●	Height Adjustable	929	954	1004	1042	1104	1179	1266	1379	1516	1691
		-39A11	●	Height and Roll Back Function	955	980	1030	1068	1130	1205	1292	1405	1542	1717
		-65A	●	Poly Loop	955	980	1030	1068	1130	1205	1292	1405	1542	1717
		-70A	●	Alum Loop	1028	1053	1103	1141	1203	1278	1365	1478	1615	1790
		-95A	●	Alum Exec 'C'	1059	1084	1134	1172	1234	1309	1396	1509	1646	1821
		-71A	○	Alum Loop - Uph	1131	1159	1215	1258	1328	1412	1510	1637	1791	1988

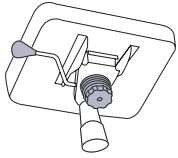

MID BACK / LARGE SEAT - *Syncro Control* (WEIGHT CAPACITY 300 LBS)

MODEL	CONTROL	ARM	QS	DESCRIPTION (SEE BELOW)	A	B	1/COM	2	3/COL	4	5	6	7	8
2205	-60C	-0A	●	No Arms	851	876	926	964	1026	1101	1188	1301	1438	1613
		-38A11	●	Height Adjustable	929	954	1004	1042	1104	1179	1266	1379	1516	1691
		-39A11	●	Height and Roll Back Function	955	980	1030	1068	1130	1205	1292	1405	1542	1717
		-65A	●	Poly Loop Arm	955	980	1030	1068	1130	1205	1292	1405	1542	1717
		-70A	●	Alum Loop	1028	1053	1103	1141	1203	1278	1365	1478	1615	1790
		-95A	●	Alum Exec 'C' Arm	1059	1084	1134	1172	1234	1309	1396	1509	1646	1821
		-71A	○	Alum Loop - Uph	1131	1159	1215	1258	1328	1412	1510	1637	1791	1988

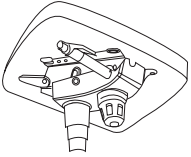

MID BACK / LARGE SEAT - *Syncro Control with Side Tension Adjustment* (WEIGHT CAPACITY 300 LBS)

MODEL	CONTROL	ARM	QS	DESCRIPTION (SEE BELOW)	A	B	1/COM	2	3/COL	4	5	6	7	8
2205	-9C	-0A	●	No Arms	903	928	978	1016	1078	1153	1240	1353	1490	1665
		-38A11	●	Height Adjustable	981	1006	1056	1094	1156	1231	1318	1431	1568	1743
		-39A11	●	Height and Roll Back Function	1007	1032	1082	1120	1182	1257	1344	1457	1594	1769
		-65A	●	Poly Loop	1007	1032	1082	1120	1182	1257	1344	1457	1594	1769
		-70A	●	Alum Loop	1080	1105	1155	1193	1255	1330	1417	1530	1667	1842
		-95A	●	Alum Exec 'C'	1111	1136	1186	1224	1286	1361	1448	1561	1698	1873
		-71A	○	Alum Loop - Uph	1183	1211	1267	1310	1380	1464	1562	1689	1843	2040

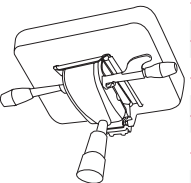

STANDARD ARM OPTIONS

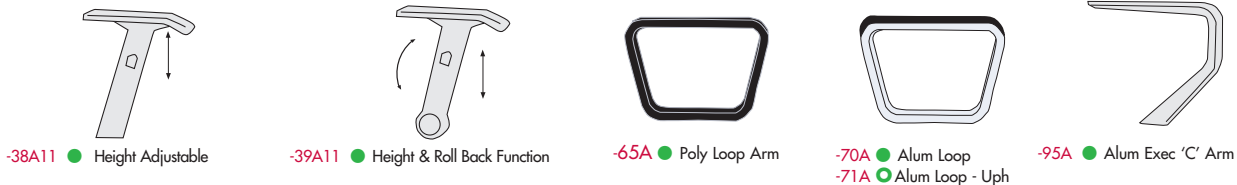

STANDARD CHAIR OPTIONS

SUFFIX	QS	DESCRIPTION	PRICE
-9	●	Four Way Adjustable Arm Cap (38A or 39A)	\$31 List
-30SS	●	Seat Slide Option (-60C, -9C)	\$73 List
-16SC	●	Hard Floor Casters	\$23 List
-16GL	●	Glides	\$23 List
-17PB	●	High Profile Polished Aluminum Base	\$73 List
-11CB	○	Custom Stain Base	\$223 List
-21TB133	○	Fire Rated Products	\$159 List

BACK AND SEAT SHELL COLOR OPTIONS

-07B	Black plastic set for mid back	No Charge
-07W	White plastic set for mid back	Upcharge - \$52 List
-07G	Gray plastic set for mid back	Upcharge - \$52 List

DUALITY

MID BACK / MEDIUM SEAT EXECUTIVE / CONFERENCE

True 48-Hour Commitment

- **20/48** 20 Chairs Every 48 Hours
- **10/48** 10 Chairs Every 48 Hours

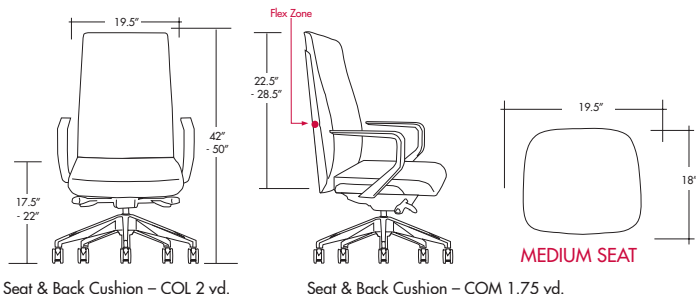

Seat & Back Cushion - COL 2 yd.

Seat & Back Cushion - COM 1.75 yd.

MID BACK / MEDIUM SEAT - *Knee Tilt Control* (WEIGHT CAPACITY 300 LBS)

MODEL	CONTROL	ARM	QS	DESCRIPTION (SEE BELOW)	A	B	1/COM	2	3/COL	4	5	6	7	8
2105	-12C	-0A	●	No Arms	779	804	854	892	954	1029	1116	1229	1366	1541
		-38A11	●	Height Adjustable	857	882	932	970	1032	1107	1194	1307	1444	1619
		-39A11	●	Height and Roll Back Function	883	908	958	996	1058	1133	1220	1333	1470	1645
		-65A	●	Poly Loop	883	908	958	996	1058	1133	1220	1333	1470	1645
		-70A	●	Alum Loop	955	980	1030	1068	1130	1205	1292	1405	1542	1717
		-95A	●	Alum Exec 'C'	987	1012	1062	1100	1162	1237	1324	1437	1574	1749
		-71A	○	Alum Loop - Uph	1058	1086	1142	1185	1255	1339	1437	1564	1718	1915

MID BACK / MEDIUM SEAT - *Syncro Control* (WEIGHT CAPACITY 300 LBS)

MODEL	CONTROL	ARM	QS	DESCRIPTION (SEE BELOW)	A	B	1/COM	2	3/COL	4	5	6	7	8
2105	-60C	-0A	●	No Arms	779	804	854	892	954	1029	1116	1229	1366	1541
		-38A11	●	Height Adjustable	857	882	932	970	1032	1107	1194	1307	1444	1619
		-39A11	●	Height and Roll Back Function	883	908	958	996	1058	1133	1220	1333	1470	1645
		-65A	●	Poly Loop	883	908	958	996	1058	1133	1220	1333	1470	1645
		-70A	●	Alum Loop	955	980	1030	1068	1130	1205	1292	1405	1542	1717
		-95A	●	Alum Exec 'C'	987	1012	1062	1100	1162	1237	1324	1437	1574	1749
		-71A	○	Alum Loop - Uph	1058	1086	1142	1185	1255	1339	1437	1564	1718	1915

MID BACK / MEDIUM SEAT - *Syncro Control with Side Tension Adjustment* (WEIGHT CAPACITY 300 LBS)

MODEL	CONTROL	ARM	QS	DESCRIPTION (SEE BELOW)	A	B	1/COM	2	3/COL	4	5	6	7	8
2105	-9C	-0A	●	No Arms	831	856	906	944	1006	1081	1168	1281	1418	1593
		-38A11	●	Height Adjustable	909	934	984	1022	1084	1159	1246	1359	1496	1671
		-39A11	●	Height and Roll Back Function	935	960	1010	1048	1110	1185	1272	1385	1522	1697
		-65A	●	Poly Loop	935	960	1010	1048	1110	1185	1272	1385	1522	1697
		-70A	●	Alum Loop	1007	1032	1082	1120	1182	1257	1344	1457	1594	1769
		-95A	●	Alum Exec 'C'	1039	1064	1114	1152	1214	1289	1376	1489	1626	1801
		-71A	○	Alum Loop - Uph	1110	1138	1194	1237	1307	1391	1489	1616	1770	1967

STANDARD ARM OPTIONS

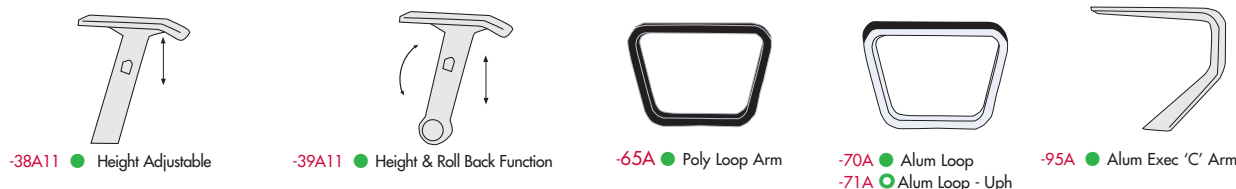

STANDARD CHAIR OPTIONS

SUFFIX	QS	DESCRIPTION	PRICE
-9	●	Four Way Adjustable Arm Cap (38A or 39A)	\$31 List
-30SS	●	Seat Slide Option (-60C, -9C)	\$73 List
-16SC	●	Hard Floor Casters	\$23 List
-16GL	●	Glides	\$23 List
-17PB	●	High Profile Polished Aluminum Base	\$73 List
-11CB	○	Custom Stain Base	\$223 List
-21TB133	○	Fire Rated Products	\$159 List

BACK AND SEAT SHELL COLOR OPTIONS

-07B	Black plastic set for mid back	No Charge
-07W	White plastic set for mid back	Upcharge - \$52 List
-07G	Gray plastic set for mid back	Upcharge - \$52 List

DUALITY

TASK MID BACK / LARGE SEAT

TASK

True 48-Hour Commitment

- **20/48** 20 Chairs Every 48 Hours
- **10/48** 10 Chairs Every 48 Hours

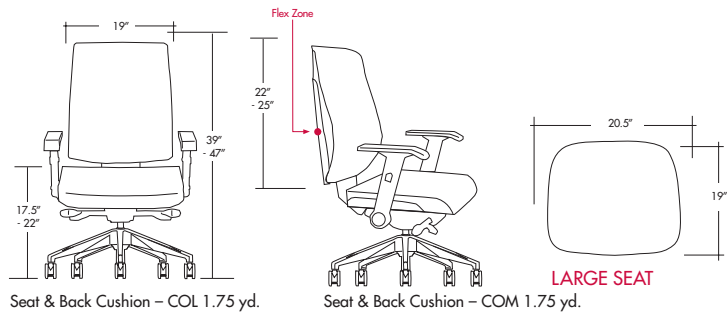

TASK MID BACK / LARGE SEAT - *Knee Tilt Control* (WEIGHT CAPACITY 300 LBS)

MODEL	CONTROL	ARM	QS	DESCRIPTION (SEE BELOW)	A	B	1/COM	2	3/COL	4	5	6	7	8
2203	-12C	-0A	●	No Arms	747	769	813	846	900	966	1042	1141	1261	1414
		-38A11	●	Height Adjustable	825	847	891	924	978	1044	1120	1219	1339	1492
		-39A11	●	Height and Roll Back Function	851	873	917	950	1002	1070	1146	1245	1365	1518
		-65A	●	Poly Loop Arm	851	873	917	950	1004	1070	1146	1245	1365	1518
		-70A	●	Alum Loop	924	946	990	1023	1077	1143	1219	1318	1438	1591
		-71A	○	Alum Loop - Uph	1026	1051	1101	1139	1201	1276	1363	1476	1613	1788

TASK MID BACK / LARGE SEAT - *Syncro Control* (WEIGHT CAPACITY 300 LBS)

MODEL	CONTROL	ARM	QS	DESCRIPTION (SEE BELOW)	A	B	1/COM	2	3/COL	4	5	6	7	8
2203	-60C	-0A	●	No Arms	747	769	813	846	900	966	1042	1141	1261	1414
		-38A11	●	Height Adjustable	825	847	891	924	978	1044	1120	1219	1339	1492
		-39A11	●	Height and Roll Back Function	851	873	917	950	1004	1070	1146	1245	1365	1518
		-65A	●	Poly Loop Arm	851	873	917	950	1004	1070	1146	1245	1365	1518
		-70A	●	Alum Loop	924	946	990	1023	1077	1143	1219	1318	1438	1591
		-71A	○	Alum Loop - Uph	1026	1051	1101	1139	1201	1276	1363	1476	1613	1788

TASK MID BACK / LARGE SEAT - *Syncro Control with Side Tension Adjustment* (WEIGHT CAPACITY 300 LBS)

MODEL	CONTROL	ARM	QS	DESCRIPTION (SEE BELOW)	A	B	1/COM	2	3/COL	4	5	6	7	8
2203	-9C	-0A	●	No Arms	799	821	865	898	952	1018	1094	1193	1313	1466
		-38A11	●	Height Adjustable	877	899	943	976	1030	1096	1172	1271	1391	1544
		-39A11	●	Height and Roll Back Function	903	925	969	1002	1056	1122	1198	1297	1417	1570
		-65A	●	Poly Loop Arm	903	925	969	1002	1056	1122	1198	1297	1417	1570
		-70A	●	Alum Loop	976	998	1042	1075	1129	1195	1271	1370	1490	1643
		-71A	○	Alum Loop - Uph	1078	1103	1153	1191	1253	1328	1415	1528	1665	1840

STANDARD ARM OPTIONS

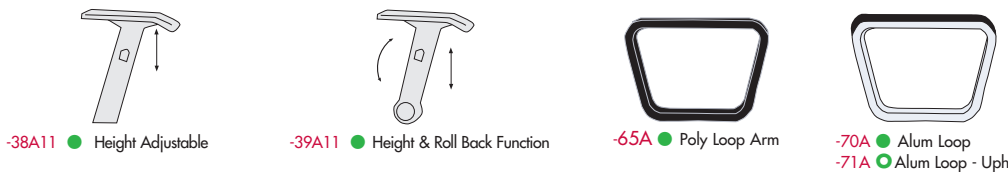

STANDARD CHAIR OPTIONS

SUFFIX	QS	DESCRIPTION	PRICE
-9	●	Four Way Adjustable Arm Cap (38A or 39A)	\$31 List
-30SS	●	Seat Slide Option (-60C, -9C)	\$73 List
-16SC	●	Hard Floor Casters	\$23 List
-16GL	●	Glides	\$23 List
-17PB	●	High Profile Polished Aluminum Base	\$73 List
-21TB133	○	Fire Rated Products	\$92 List

BACK AND SEAT SHELL COLOR OPTIONS

-03B	Black plastic set for mid back	No Charge
-03W	White plastic set for mid back	Upcharge - \$52 List
-03G	Gray plastic set for mid back	Upcharge - \$52 List

True 48-Hour Commitment

- **20/48** 20 Chairs Every 48 Hours
- **10/48** 10 Chairs Every 48 Hours

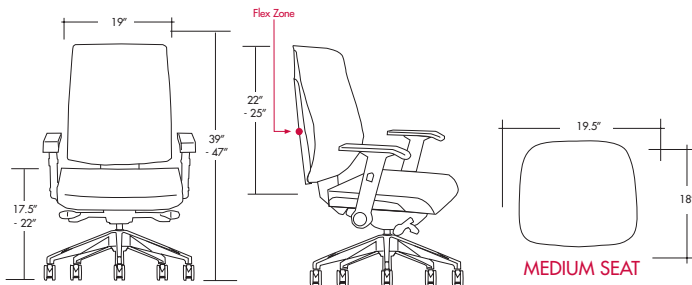

Seat & Back Cushion - COL 1.75 yd.

Seat & Back Cushion - COM 1.5 yd.

MEDIUM SEAT

TASK MID BACK / MEDIUM SEAT - *Knee Tilt Control* (WEIGHT CAPACITY 300 LBS)

MODEL	CONTROL	ARM	QS	DESCRIPTION (SEE BELOW)	A	B	1/COM	2	3/COL	4	5	6	7	8
2103	-12C	-0A	●	No Arms	674	696	740	773	827	893	969	1068	1188	1341
		-38A11	●	Height Adjustable	752	774	818	851	905	971	1047	1146	1266	1419
		-39A11	●	Height and Roll Back Function	778	800	844	877	931	997	1073	1172	1292	1445
		-65A	●	Poly Loop Arm	778	800	844	877	931	997	1073	1172	1292	1445
		-70A	●	Alum Loop	851	873	917	950	1004	1070	1146	1245	1365	1518
		-71A	○	Alum Loop - Uph	953	978	1028	1066	1128	1203	1290	1403	1540	1715

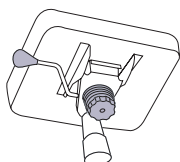

TASK MID BACK / MEDIUM SEAT - *Syncro Control* (WEIGHT CAPACITY 300 LBS)

MODEL	CONTROL	ARM	QS	DESCRIPTION (SEE BELOW)	A	B	1/COM	2	3/COL	4	5	6	7	8
2103	-60C	-0A	●	No Arms	674	696	740	773	827	893	969	1068	1188	1341
		-38A11	●	Height Adjustable	752	774	818	851	905	971	1047	1146	1266	1419
		-39A11	●	Height and Roll Back Function	778	800	844	877	931	997	1073	1172	1292	1445
		-65A	●	Poly Loop Arm	778	800	844	877	931	997	1073	1172	1292	1445
		-70A	●	Alum Loop	851	873	917	950	1004	1070	1146	1245	1365	1518
		-71A	○	Alum Loop - Uph	953	978	1028	1066	1128	1203	1290	1403	1540	1715

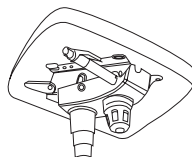

TASK MID BACK / MEDIUM SEAT - *Syncro Control with Side Tension Adjustment* (WEIGHT CAPACITY 300 LBS)

MODEL	CONTROL	ARM	QS	DESCRIPTION (SEE BELOW)	A	B	1/COM	2	3/COL	4	5	6	7	8
2103	-9C	-0A	●	No Arms	726	748	792	825	879	945	1021	1120	1240	1393
		-38A11	●	Height Adjustable	804	826	870	903	957	1023	1099	1198	1318	1471
		-39A11	●	Height and Roll Back Function	830	852	896	929	983	1049	1125	1224	1344	1497
		-65A	●	Poly Loop Arm	830	852	896	929	983	1049	1125	1224	1344	1497
		-70A	●	Alum Loop	903	925	969	1002	1056	1122	1198	1297	1417	1570
		-71A	○	Alum Loop - Uph	1005	1030	1080	1118	1180	1255	1342	1455	1592	1767

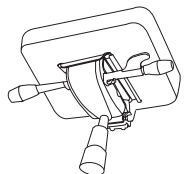

STANDARD ARM OPTIONS



-38A11 ● Height Adjustable

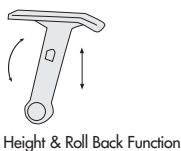

-39A11 ● Height & Roll Back Function



-65A ● Poly Loop Arm



-70A ● Alum Loop
-71A ○ Alum Loop - Uph

STANDARD CHAIR OPTIONS

SUFFIX	QS	DESCRIPTION	PRICE
-9	●	Four Way Adjustable Arm Cap (38A or 39A)	\$31 List
-30SS	●	Seat Slide Option (-60C, -9C)	\$73 List
-16SC	●	Hard Floor Casters	\$23 List
-16GL	●	Glides	\$23 List
-17PB	●	High Profile Polished Aluminum Base	\$73 List
-21TB133	○	Fire Rated Products	\$92 List

BACK AND SEAT SHELL COLOR OPTIONS

-03B	Black plastic set for mid back	No Charge
-03W	White plastic set for mid back	Upcharge - \$52 List
-03G	Gray plastic set for mid back	Upcharge - \$52 List

DUALITY

TASK LOW BACK / LARGE SEAT

TASK

True 48-Hour Commitment

- **20/48** 20 Chairs Every 48 Hours
- **10/48** 10 Chairs Every 48 Hours

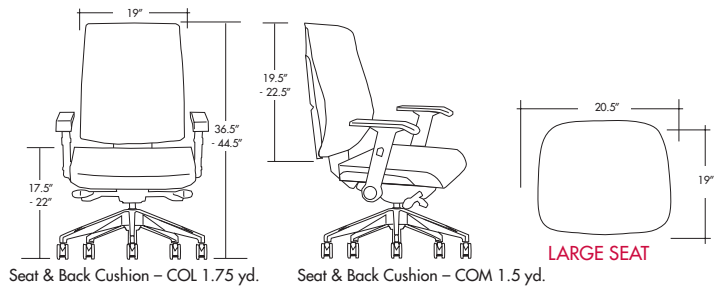

TASK LOW BACK / LARGE SEAT - *Knee Tilt Control* (WEIGHT CAPACITY 300 LBS)

MODEL	CONTROL	ARM	QS	DESCRIPTION (SEE BELOW)	A	B	1/COM	2	3/COL	4	5	6	7	8
2201	-12C	-0A	●	No Arms	695	717	761	794	848	914	990	1089	1209	1362
		-38A11	●	Height Adjustable	773	795	839	872	926	992	1068	1167	1287	1440
		-39A11	●	Height and Roll Back Function	799	821	865	898	952	1018	1094	1193	1313	1466
		-65A	●	Poly Loop Arm	799	821	865	898	952	1018	1094	1193	1313	1466
		-70A	●	Alum Loop	872	894	938	971	1025	1091	1167	1266	1386	1539
		-71A	○	Alum Loop - Uph	974	999	1049	1087	1149	1224	1311	1424	1561	1736

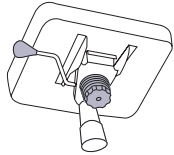

TASK LOW BACK / LARGE SEAT - *Syncro Control* (WEIGHT CAPACITY 300 LBS)

MODEL	CONTROL	ARM	QS	DESCRIPTION (SEE BELOW)	A	B	1/COM	2	3/COL	4	5	6	7	8
2201	-60C	-0A	●	No Arms	695	717	761	794	848	914	990	1089	1209	1362
		-38A11	●	Height Adjustable	773	795	839	872	926	992	1068	1167	1287	1440
		-39A11	●	Height and Roll Back Function	799	821	865	898	952	1018	1094	1193	1313	1466
		-65A	●	Poly Loop Arm	799	821	865	898	952	1018	1094	1193	1313	1466
		-70A	●	Alum Loop	872	894	938	971	1025	1091	1167	1266	1386	1539
		-71A	○	Alum Loop - Uph	974	999	1049	1087	1149	1224	1311	1424	1561	1736

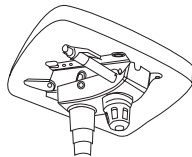

TASK LOW BACK / LARGE SEAT - *Syncro Control with Side Tension Adjustment* (WEIGHT CAPACITY 300 LBS)

MODEL	CONTROL	ARM	QS	DESCRIPTION (SEE BELOW)	A	B	1/COM	2	3/COL	4	5	6	7	8
2201	-9C	-0A	●	No Arms	747	769	813	846	900	966	1042	1141	1261	1414
		-38A11	●	Height Adjustable	825	847	891	924	978	1044	1120	1219	1339	1492
		-39A11	●	Height and Roll Back Function	851	873	917	950	1004	1070	1146	1245	1365	1518
		-65A	●	Poly Loop Arm	851	873	917	950	1004	1070	1146	1245	1365	1518
		-70A	●	Alum Loop	924	946	990	1023	1077	1143	1219	1318	1438	1591
		-71A	○	Alum Loop - Uph	1026	1051	1101	1139	1201	1276	1363	1476	1613	1788

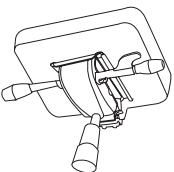

STANDARD ARM OPTIONS

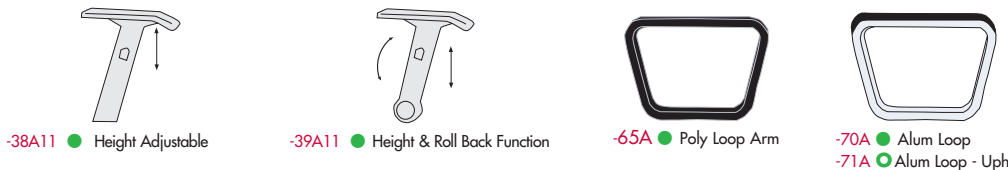

STANDARD CHAIR OPTIONS

SUFFIX	QS	DESCRIPTION	PRICE
-9	●	Four Way Adjustable Arm Cap (38A or 39A)	\$31 List
-30SS	●	Seat Slide Option (-60C, -9C)	\$73 List
-16SC	●	Hard Floor Casters	\$23 List
-16GL	●	Glides	\$23 List
-17PB	●	High Profile Polished Aluminum Base	\$73 List
-21TB133	○	Fire Rated Products	\$92 List

BACK AND SEAT SHELL COLOR OPTIONS

-01B	Black plastic set for mid back	No Charge
-01W	White plastic set for mid back	Upcharge - \$52 List
-01G	Gray plastic set for mid back	Upcharge - \$52 List

DUALITY

TASK LOW BACK / MEDIUM SEAT

TASK

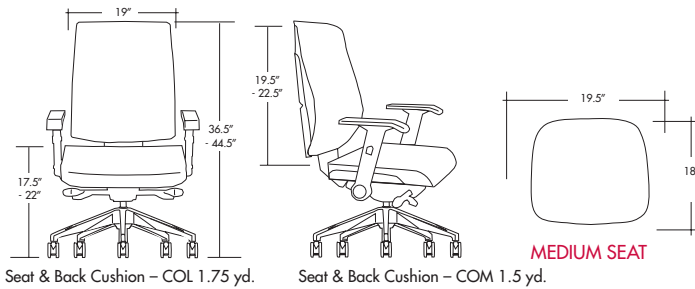

True 48-Hour Commitment

- **20/48** 20 Chairs Every 48 Hours
- **10/48** 10 Chairs Every 48 Hours

TASK LOW BACK / MEDIUM SEAT - *Knee Tilt Control* (WEIGHT CAPACITY 300 LBS)

MODEL	CONTROL	ARM	QS	DESCRIPTION (SEE BELOW)	A	B	1/COM	2	3/COL	4	5	6	7	8
2101	-12C	-0A	●	No Arms	622	644	688	721	775	827	917	1016	1136	1289
		-38A11	●	Height Adjustable	700	722	766	799	853	919	995	1094	1214	1367
		-39A11	●	Height and Roll Back Function	726	748	792	825	879	945	1021	1120	1240	1393
		-65A	●	Poly Loop Arm	726	748	792	825	879	945	1021	1120	1240	1393
		-70A	●	Alum Loop	799	821	865	898	952	1018	1094	1193	1313	1466
		-71A	○	Alum Loop - Uph	901	926	976	1014	1076	1151	1238	1351	1488	1663

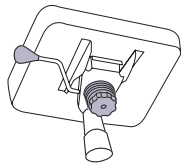

TASK LOW BACK / MEDIUM SEAT - *Syncro Control* (WEIGHT CAPACITY 300 LBS)

MODEL	CONTROL	ARM	QS	DESCRIPTION (SEE BELOW)	A	B	1/COM	2	3/COL	4	5	6	7	8
2101	-60C	-0A	●	No Arms	622	644	688	721	775	827	917	1016	1136	1289
		-38A11	●	Height Adjustable	700	722	766	799	853	919	995	1094	1214	1367
		-39A11	●	Height and Roll Back Function	726	748	792	825	879	945	1021	1120	1240	1393
		-65A	●	Poly Loop Arm	726	748	792	825	879	945	1021	1120	1240	1393
		-70A	●	Alum Loop	799	821	865	898	952	1018	1094	1193	1313	1466
		-71A	○	Alum Loop - Uph	901	926	976	1014	1076	1151	1238	1351	1488	1663

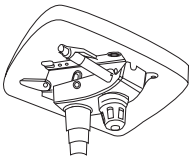

TASK LOW BACK / MEDIUM SEAT - *Syncro Control with Side Tension Adjustment* (WEIGHT CAPACITY 300 LBS)

MODEL	CONTROL	ARM	QS	DESCRIPTION (SEE BELOW)	A	B	1/COM	2	3/COL	4	5	6	7	8
2101	-9C	-0A	●	No Arms	674	696	740	773	827	893	969	1068	1188	1341
		-38A11	●	Height Adjustable	752	774	818	851	905	971	1047	1146	1266	1419
		-39A11	●	Height and Roll Back Function	778	800	844	877	931	997	1073	1172	1292	1445
		-65A	●	Poly Loop Arm	778	800	844	877	931	997	1073	1172	1292	1445
		-70A	●	Alum Loop	851	873	917	950	1004	1070	1146	1245	1365	1518
		-71A	○	Alum Loop - Uph	953	978	1028	1066	1128	1203	1290	1403	1540	1715

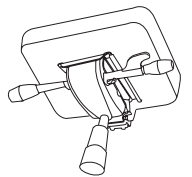

STANDARD ARM OPTIONS

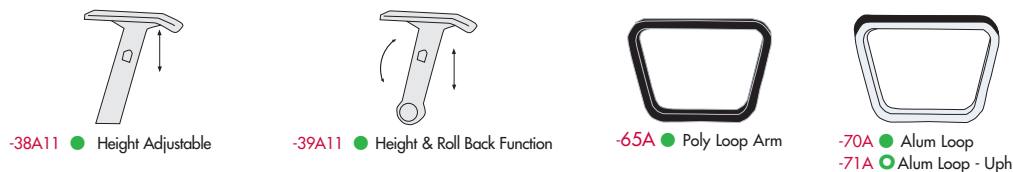

STANDARD CHAIR OPTIONS

SUFFIX	QS	DESCRIPTION	PRICE
-9	●	Four Way Adjustable Arm Cap (38A or 39A)	\$31 List
-30SS	●	Seat Slide Option (-60C, -9C)	\$73 List
-16SC	●	Hard Floor Casters	\$23 List
-16GL	●	Glides	\$23 List
-17PB	●	High Profile Polished Aluminum Base	\$73 List
-21TB133	○	Fire Rated Products	\$92 List

BACK AND SEAT SHELL COLOR OPTIONS

-01B	Black plastic set for mid back	No Charge
-01W	White plastic set for mid back	Upcharge - \$52 List
-01G	Gray plastic set for mid back	Upcharge - \$52 List