

VOSS

EXECUTIVE | CONFERENCE | TASK



Voss Executive Model: 2V25-29C-23A8-11PB-15XC





It's more than just a chair.®

VOSS

FULL SCALE HIGH BACK

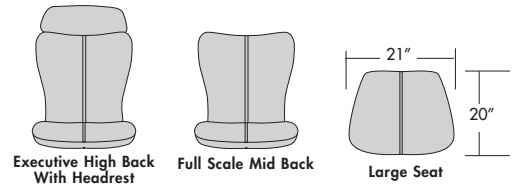
PLANNING GUIDE

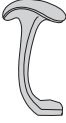
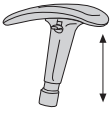

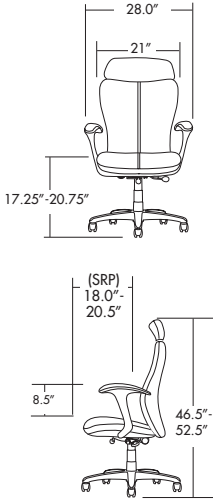
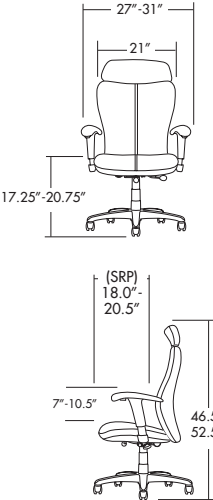
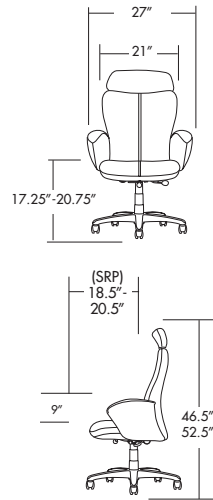
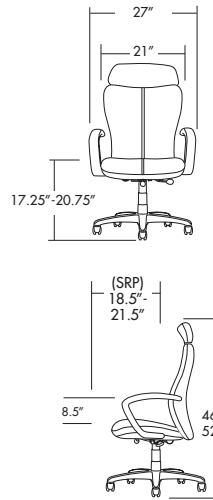
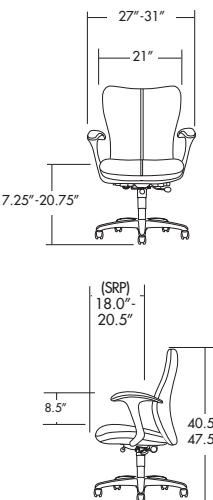
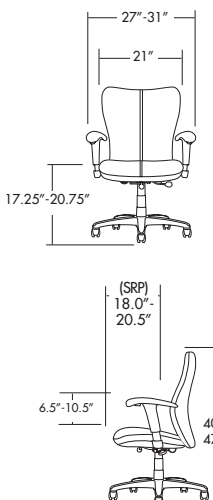
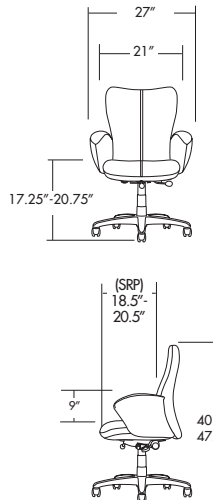
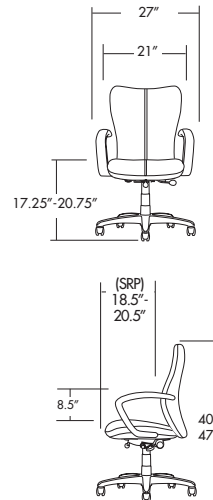
ARM STYLES	 Aluminum Arm -57A ● Brushed Aluminum -58A ● Polished Aluminum	 Adjustable Height Arm -22A Black Upright -23A Chrome Upright	 Panel Arm -19A Full Upholstered	 Executive "C" Arm -80A Non-Upholstered -90A Full Upholstered
ARM CAPS	<ul style="list-style-type: none"> • Polyurethane Caps (Standard) • Upholstered Caps COM Add - .25 yd. COL Add - 3.5 sq. ft.	<ul style="list-style-type: none"> • Polyurethane Caps (Standard) • Upholstered Caps COM Add - .5 yd. COL Add - 4 sq. ft.	<ul style="list-style-type: none"> • Upholstered Arms COM Add - 1 yd. COL Add - 15 sq. ft.	<ul style="list-style-type: none"> • Upholstered Arms COM Add - 1 yd. COL Add - 8 sq. ft.
FULL SCALE HIGH BACK LARGE SEAT				
FULL SCALE MID BACK LARGE SEAT				

VOSS MID SCALE HIGH BACK PLANNING GUIDE

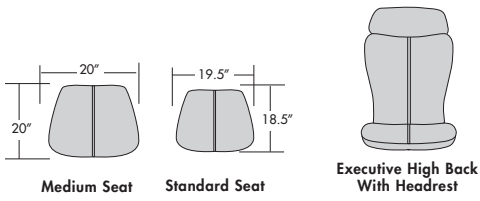

Medium Seat

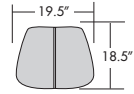

Standard Seat

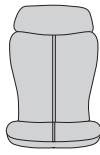

Executive High Back
With Headrest

ARM STYLES	<p>-39A Swing-Back Adjustable Height Arm</p>	<p>Adjustable Height Arm -22A Black Upright -23A Chrome Upright</p>	<p>Panel Arm -19A Full Upholstered</p>	<p>Executive "C" Arm -80A Non-Upholstered -90A Full Upholstered</p>
ARM CAPS	<ul style="list-style-type: none"> • Polyurethane Caps (Standard) • Upholstered Caps <p>COM Add - .25 yd. COL Add - 3.5 sq. ft.</p>	<ul style="list-style-type: none"> • Polyurethane Caps (Standard) • Upholstered Caps <p>COM Add - .5 yd. COL Add - 4 sq. ft.</p>	<ul style="list-style-type: none"> • Upholstered Arms <p>COM Add - 1 yd. COL Add - 15 sq. ft.</p>	<ul style="list-style-type: none"> • Upholstered Arms <p>COM Add - 1 yd. COL Add - 8 sq. ft.</p>
MID SCALE HIGH BACK MEDIUM SEAT				
FULL SCALE MID BACK LARGE SEAT				



VOSS CONFERENCE PLANNING GUIDE

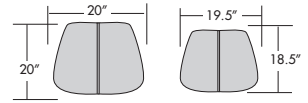

Conference

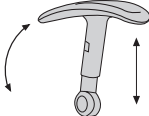
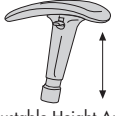

Medium Seat Standard Seat

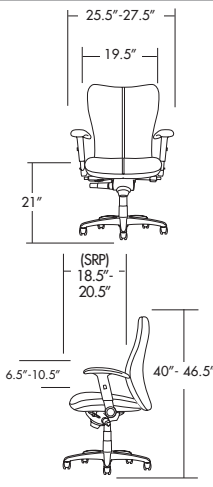
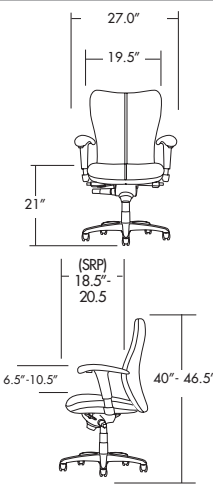
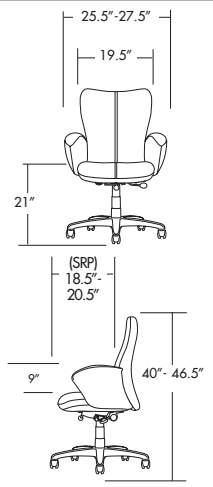
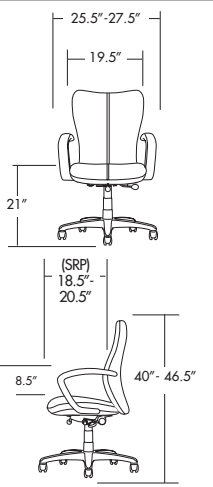
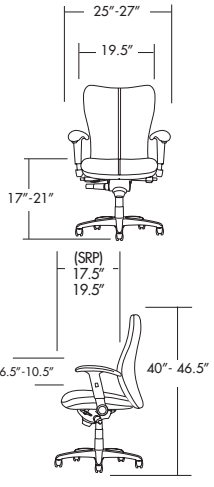
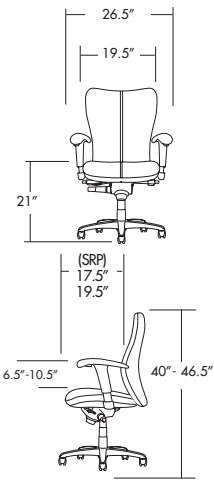
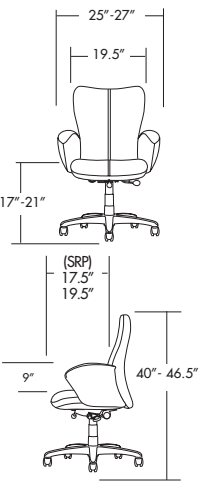
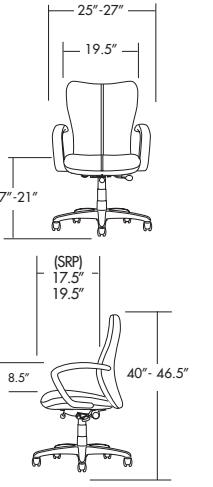
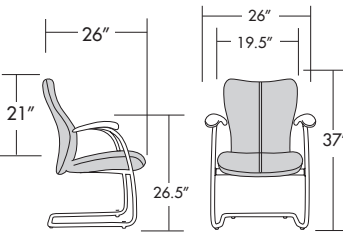
ARM STYLES	 -39A Swing-Back Adjustable Height Arm	 Adjustable Height Arm -22A Black Upright -23A Chrome Upright	 Panel Arm -19A Full Upholstered	 Executive "C" Arm -80A Non-Upholstered -90A Full Upholstered																														
ARM CAPS	<ul style="list-style-type: none"> • Polyurethane Caps (Standard) • Upholstered Caps COM Add - .25 yd. COL Add - 3.5 sq. ft.	<ul style="list-style-type: none"> • Polyurethane Caps (Standard) • Upholstered Caps COM Add - .5 yd. COL Add - 4 sq. ft.	<ul style="list-style-type: none"> • Upholstered Arms COM Add - 1 yd. COL Add - 15 sq. ft.	<ul style="list-style-type: none"> • Upholstered Arms COM Add - 1 yd. COL Add - 8 sq. ft.																														
MID BACK MEDIUM SEAT																																		
MID BACK STANDARD SEAT																																		
SIDE/GUEST CHAIR MEDIUM SEAT				<table border="1"> <thead> <tr> <th></th> <th>ARMS</th> <th>ARMLESS</th> </tr> </thead> <tbody> <tr> <td>Overall Width</td> <td>25.5</td> <td>19</td> </tr> <tr> <td>Overall Depth</td> <td>22.5</td> <td>22.5</td> </tr> <tr> <td>Overall Height</td> <td>36</td> <td>36</td> </tr> <tr> <td>Seat Width</td> <td>18</td> <td>18</td> </tr> <tr> <td>Seat Depth</td> <td>17</td> <td>17</td> </tr> <tr> <td>Seat Height</td> <td>18</td> <td>18</td> </tr> <tr> <td>Back Width</td> <td>19</td> <td>19</td> </tr> <tr> <td>Back Height</td> <td>19</td> <td>19</td> </tr> <tr> <td>Arm Height</td> <td></td> <td></td> </tr> </tbody> </table> <p>Cap: Durable steel reinforced self-skinned urethane.</p>		ARMS	ARMLESS	Overall Width	25.5	19	Overall Depth	22.5	22.5	Overall Height	36	36	Seat Width	18	18	Seat Depth	17	17	Seat Height	18	18	Back Width	19	19	Back Height	19	19	Arm Height		
	ARMS	ARMLESS																																
Overall Width	25.5	19																																
Overall Depth	22.5	22.5																																
Overall Height	36	36																																
Seat Width	18	18																																
Seat Depth	17	17																																
Seat Height	18	18																																
Back Width	19	19																																
Back Height	19	19																																
Arm Height																																		



VOSS TASK AND MESH BACK PLANNING GUIDE

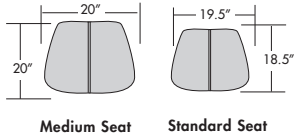

Medium Seat

Standard Seat

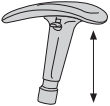
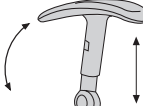
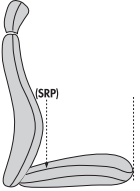
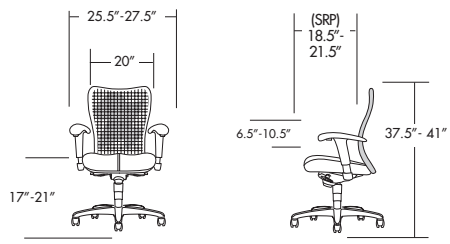
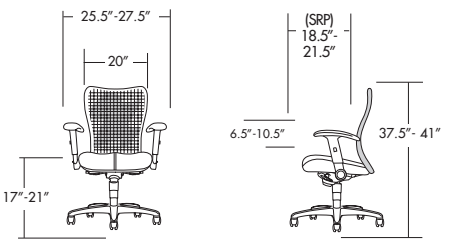
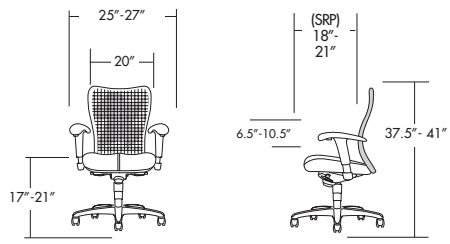
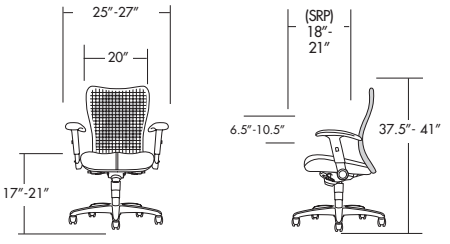
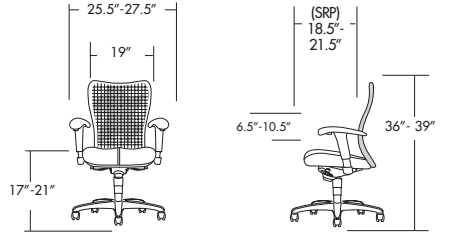
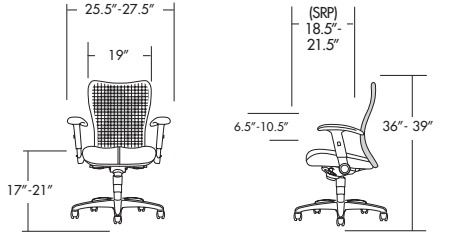
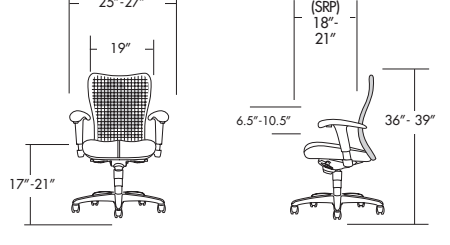
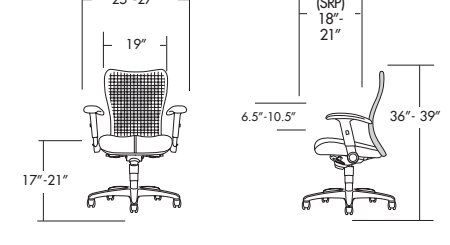
<p style="writing-mode: vertical-rl; transform: rotate(180deg);">ARM STYLES</p>	 <p>Adjustable Height Arm -22A Black Upright -23A Chrome Upright</p>	 <p>-39A Swing-Back Adjustable Height Arm</p>	 <p>ACCORDING TO ANSI, The seat reference point (SRP) is the distance from a slight indentation in the lumbar to the front of the seat.</p>
<p style="writing-mode: vertical-rl; transform: rotate(180deg);">ARM CAPS</p>	<ul style="list-style-type: none"> • Polyurethane Caps (Standard) • Upholstered Caps <p>COM Add - .25 yd. COL Add - 3.5 sq. ft.</p>	<ul style="list-style-type: none"> • Polyurethane Caps (Standard) • Upholstered Caps <p>COM Add - .5 yd. COL Add - 4 sq. ft.</p>	
<p style="writing-mode: vertical-rl; transform: rotate(180deg);">HIGH BACK MESH MEDIUM SEAT</p>			
<p style="writing-mode: vertical-rl; transform: rotate(180deg);">HIGH BACK MESH STANDARD SEAT</p>			
<p style="writing-mode: vertical-rl; transform: rotate(180deg);">MID MESH BACK MEDIUM SEAT</p>			
<p style="writing-mode: vertical-rl; transform: rotate(180deg);">MID MESH BACK STANDARD SEAT</p>			

VOSS

FULL SCALE HIGH BACK / LARGE SEAT

EXECUTIVE / CONFERENCE

True 48-Hour Commitment

- **20/48** 20 Chairs Every 48 Hours
- **10/48** 10 Chairs Every 48 Hours

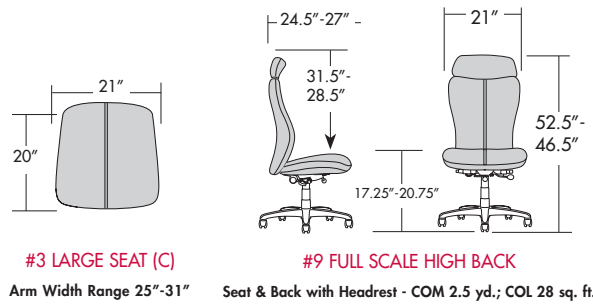

FULL SCALE HIGH BACK WITH ARTICULATING HEADREST - *Torsion Syncro Control / Seat Slider* (WEIGHT CAPACITY 300 LBS)

MODEL	CONTROL	ARM	QS	DESCRIPTION (SEE BELOW)	A	B	1/COM	2	3/COL	4	5	6	7	8
1V39	-40C	-22A8	●	Adjustable Height Arm (Black)	1715	1750	1795	1866	1961	2111	2358	2569	2750	2993
		-23A8	●	Adjustable Height Arm (Chrome)	1715	1750	1795	1866	1961	2111	2358	2569	2750	2993
		-19A	○	Panel Arm Full Upholstered	1818	1853	1898	1969	2064	2214	2538	2749	2930	3173
		-57A	●	Aluminum Arm (Brushed)*	1818	1853	1898	1969	2064	2214	2461	2672	2853	3096
		-58A	●	Aluminum Arm (Polished)*	1829	1865	1909	1980	2076	2226	2472	2683	2864	3108
		-80A	●	Executive "C" Arm Non-Upholstered	1772	1808	1852	1923	2019	2168	2415	2626	2807	3050
		-90A	○	Executive "C" Arm Full Upholstered	1841	1876	1921	1992	2087	2237	2528	2739	2920	3164

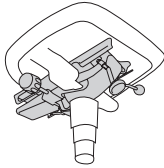

FULL SCALE HIGH BACK WITH ARTICULATING HEADREST - *Torsion Syncro Control / Ergo-Tilt Seat / Seat Slider* (WEIGHT CAPACITY 300 LBS)

MODEL	CONTROL	ARM	QS	DESCRIPTION (SEE BELOW)	A	B	1/COM	2	3/COL	4	5	6	7	8
1V39	-41C	-22A8	●	Adjustable Height Arm (Black)	1923	1958	2003	2074	2169	2319	2566	2777	2958	3201
		-23A8	●	Adjustable Height Arm (Chrome)	1923	1958	2003	2074	2169	2319	2566	2777	2958	3201
		-19A	○	Panel Arm Full Upholstered	2026	2061	2106	2177	2272	2422	2746	2957	3138	3381
		-57A	●	Aluminum Arm (Brushed)*	2026	2061	2106	2177	2272	2422	2669	2880	3061	3304
		-58A	●	Aluminum Arm (Polished)*	2037	2073	2117	2188	2284	2434	2680	2891	3072	3316
		-80A	●	Executive "C" Arm Non-Upholstered	1980	2016	2060	2131	2227	2376	2623	2834	3015	3258
		-90A	○	Executive "C" Arm Full Upholstered	2049	2084	2129	2200	2295	2445	2736	2947	3128	3372

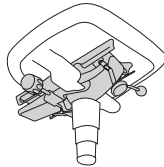

STANDARD ARM OPTIONS

How to Specify: **1V39-41C-57A-5UC-11CB**

SEAT: 1V39
UPHOLSTERED ARM CAPS: 11CB
BACK CONTROL: 41C
ARM STYLE: 57A
OPTION: 5UC

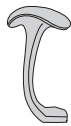

Aluminum Arm
-57A ● Brushed Aluminum
-58A ● Polished Aluminum

For: COM Add - .25 yd.
COL Add - 3.5 sq. ft.

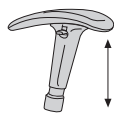

Adjustable Height Arm
-22A8 ● Black Upright
-23A8 ● Chrome Upright

For: COM Add - .5 yd.
COL Add - 4 sq. ft.



Executive "C" Arm
-80A ● Non-Upholstered
-90A ● Full Upholstered

For: COM Add - 1 yd.
COL Add - 8 sq. ft.

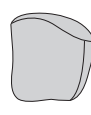

Panel Arm
-19A ● Full Upholstered

For: COM Add - .75 yd.
COL Add - 15 sq. ft.

STANDARD CHAIR OPTIONS

SUFFIX	QS DESCRIPTION	PRICE	SUFFIX	QS DESCRIPTION	PRICE
-9	● Four Way Adjustable Arm Cap (22A, 23A)	\$31 List	-2UC	○ Upholstered Caps - Adjustable Arms	\$49 List
-13AIR	● Air Lumbar	\$66 List	-11CB	○ Custom Stain Base (5 chair minimum)	\$223 List
-15SC	● Hard Floor Casters	\$23 List	-21TB133	○ Fire Rated Products (see page 11)	\$159 List
-15GL	● Glides	\$23 List			
-15XC	● Spoked Casters	\$33 List			
-11PB	● Polished Aluminum Base	\$92 List			
-11BA	● Brushed Aluminum Base	\$92 List			
-14AB	● Adj. Width Bracket (22A, 23A only)	\$23 List			
-5UC	○ Upholstered Caps - Aluminum Arms	\$49 List			

VOSS - EXECUTIVE FULL SCALE HIGH BACK SHIPS STANDARD WITH:

- Torsion Bar - Full Syncro Control
- Black Base with Dual Wheel Black Carpet Casters
- Adjustable Height Back
- Seat Slider
- Adjustable Width Arm Brackets
- Articulating Head Rest



FULL SCALE MID BACK / LARGE SEAT
EXECUTIVE / CONFERENCE

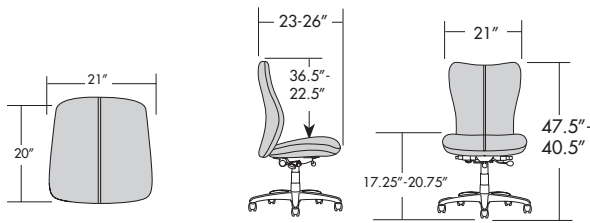

#3 LARGE SEAT (C)

Arm Width Range 25"-31"

#7 FULL SCALE EXECUTIVE BACK

Seat & Back - COM 2 yd.; COL 24 sq. ft.

True 48-Hour Commitment

- **20/48** 20 Chairs Every 48 Hours
- **10/48** 10 Chairs Every 48 Hours

FULL SCALE MID BACK - Torsion Syncro Control / Seat Slider (WEIGHT CAPACITY 300 LBS)

MODEL	CONTROL	ARM	QS	DESCRIPTION (SEE BELOW)	A	B	1/COM	2	3/COL	4	5	6	7	8
1V37	-40C	-22A8	●	Adjustable Height Arm (Black)	1464	1499	1543	1615	1710	1861	2106	2318	2530	2741
		-23A8	●	Adjustable Height Arm (Chrome)	1464	1499	1543	1615	1710	1861	2106	2318	2530	2741
		-19A	○	Panel Arm Full Upholstered	1567	1602	1646	1718	1813	1964	2286	2498	2710	2921
		-57A	●	Aluminum Arm (Brushed)*	1567	1602	1646	1718	1813	1964	2209	2421	2633	2844
		-58A	●	Aluminum Arm (Polished)*	1579	1613	1658	1730	1824	1975	2220	2433	2645	2856
		-80A	●	Executive "C" Arm Non-Upholstered	1522	1556	1601	1672	1767	1918	2163	2375	2588	2799
		-90A	○	Executive "C" Arm Full Upholstered	1590	1624	1669	1741	1836	1986	2277	2489	2701	2912

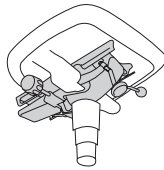

FULL SCALE MID BACK - Torsion Syncro Control / Ergo-Tilt / Seat Slider (WEIGHT CAPACITY 300 LBS)

MODEL	CONTROL	ARM	QS	DESCRIPTION (SEE BELOW)	A	B	1/COM	2	3/COL	4	5	6	7	8
1V37	-41C	-22A8	●	Adjustable Height Arm (Black)	1672	1707	1751	1823	1918	2069	2314	2526	2738	2949
		-23A8	●	Adjustable Height Arm (Chrome)	1672	1707	1751	1823	1918	2069	2314	2526	2738	2949
		-19A	○	Panel Arm Full Upholstered	1775	1810	1854	1926	2021	2172	2494	2706	2918	3129
		-57A	●	Aluminum Arm (Brushed)*	1775	1810	1854	1926	2021	2172	2417	2629	2841	3052
		-58A	●	Aluminum Arm (Polished)*	1787	1821	1866	1938	2032	2183	2428	2641	2853	3064
		-80A	●	Executive "C" Arm Non-Upholstered	1730	1764	1809	1880	1975	2126	2371	2583	2796	3007
		-90A	○	Executive "C" Arm Full Upholstered	1798	1832	1877	1949	2044	2194	2485	2697	2909	3120

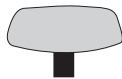
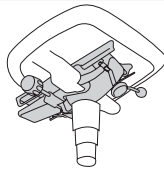

Head Rest (Optional)
-2VHR ○ Full Upholstered* (See options)
For: COM Add - 1 yd.
COL Add - 9.5 sq. ft.

STANDARD ARM OPTIONS



Aluminum Arm
-57A ● Brushed Aluminum
-58A ● Polished Aluminum

For: COM Add - .25 yd.
COL Add - 3.5 sq. ft.

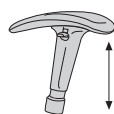

Adjustable Height Arm
-22A8 ● Black Upright
-23A8 ● Chrome Upright

For: COM Add - .5 yd.
COL Add - 4 sq. ft.



Executive "C" Arm
-80A ● Non-Upholstered
-90A ● Full Upholstered

For: COM Add - 1 yd.
COL Add - 8 sq. ft.

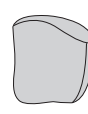

Panel Arm
-19A ○ Full Upholstered

For: COM Add - .75 yd.
COL Add - 15 sq. ft.

How to Specify:

SEAT UPHOLSTERED ARM CAPS
1V37-41C-58A-5UC-11PB
SERIES BACK | ARM STYLE | OPTION
CONTROL

STANDARD CHAIR OPTIONS

SUFFIX	QS DESCRIPTION	PRICE
-9	● Four Way Adjustable Arm Cap (22A, 23A)	\$31 List
-13AIR	● Air Lumbar	\$66 List
-15SC	● Hard Floor Casters	\$23 List
-15GL	● Glides	\$23 List
-15XC	● Spoked Casters	\$33 List
-11PB	● Polished Aluminum Base	\$92 List
-11BA	● Brushed Aluminum Base	\$92 List
-14AB	● Adj. Width Bracket (22A, 23A only)	\$23 List
-5UC	○ Upholstered Caps - Aluminum Arms	\$49 List

SUFFIX	QS DESCRIPTION	PRICE
-2UC	○ Upholstered Caps - Adjustable Arms	\$49 List
-11CB	○ Custom Stain Base (5 chair minimum)	\$223 List
-2VHR	● Full Function Head Rest	\$251 List
-21TB133	○ Fire Rated Products (see page 11)	\$159 List

VOSS - EXECUTIVE FULL SCALE HIGH BACK SHIPS STANDARD WITH:

- Torsion Bar - Full Syncro Control
- Black Base with Dual Wheel Black Carpet Casters
- Adjustable Height Back
- Seat Slider
- Adjustable Width Arm Brackets
- Articulating Head Rest

VOSS

FULL SCALE MID BACK / MEDIUM SEAT

EXECUTIVE / CONFERENCE

True 48-Hour Commitment

- **20/48** 20 Chairs Every 48 Hours
- **10/48** 10 Chairs Every 48 Hours

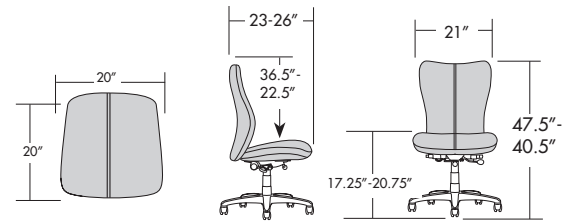

#2 MEDIUM SEAT (B)
Arm Width Range 25"-31"

#7 FULL SCALE EXECUTIVE BACK
Seat & Back - COM 2 yd.; COL 24 sq. ft.

FULL SCALE MID BACK / MEDIUM SEAT - Single Position Knee Tilt Control (WEIGHT CAPACITY 300 LBS)

MODEL	CONTROL	ARM	QS	DESCRIPTION (SEE BELOW)	A	B	1/COM	2	3/COL	4	5	6	7	8
2V27	-12C*	-38A8	●	Adjustable Height Arm	1176	1212	1256	1327	1423	1518	1819	2030	2242	2454
		-39A8	●	Swing-Back Adjustable Height Arm	1202	1238	1282	1353	1449	1544	1845	2056	2268	2480
		-22A8	●	Adjustable Height Arm (Black)	1241	1276	1321	1392	1487	1583	1883	2095	2307	2519
		-23A8	●	Adjustable Height Arm (Chrome)	1241	1276	1321	1392	1487	1583	1883	2095	2307	2519
		-19A	○	Panel Arm Full Upholstered	1344	1379	1424	1494	1590	1686	2063	2274	2487	2699
		-80A	●	Executive "C" Arm Non-Upholstered	1298	1333	1378	1449	1544	1640	1941	2152	2364	2576
		-90A	○	Executive "C" Arm Full Upholstered	1367	1402	1447	1517	1613	1709	2054	2265	2477	2689
	*-13C	For Seat Slider, Replace -12C with -13C			Add \$73 List		How to Specify: 2V27-13C-39A8							

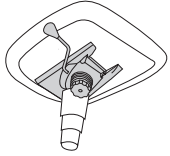

FULL SCALE MID BACK / MEDIUM SEAT - Syncro Control with Side Tension Adjustment (WEIGHT CAPACITY 300 LBS)

MODEL	CONTROL	ARM	QS	DESCRIPTION (SEE BELOW)	A	B	1/COM	2	3/COL	4	5	6	7	8
2V27	-9C	-38A8	●	Adjustable Height Arm	1228	1264	1308	1379	1475	1570	1871	2082	2294	2506
		-39A8	●	Swing-Back Adjustable Height Arm	1254	1290	1334	1405	1501	1596	1897	2108	2320	2532
		-22A8	●	Adjustable Height Arm (Black)	1293	1328	1373	1444	1539	1635	1935	2147	2359	2571
		-23A8	●	Adjustable Height Arm (Chrome)	1293	1328	1373	1444	1539	1635	1935	2147	2359	2571
		-19A	○	Panel Arm Full Upholstered	1396	1431	1476	1546	1642	1738	2115	2326	2539	2751
		-80A	●	Executive "C" Arm Non-Upholstered	1350	1385	1430	1501	1596	1692	1993	2204	2416	2628
		-90A	○	Executive "C" Arm Full Upholstered	1419	1454	1499	1569	1665	1761	2106	2317	2529	2741

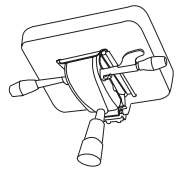

FULL SCALE MID BACK / MEDIUM SEAT - Full Function Syncro Control / Seat Slider (WEIGHT CAPACITY 300 LBS)

MODEL	CONTROL	ARM	QS	DESCRIPTION (SEE BELOW)	A	B	1/COM	2	3/COL	4	5	6	7	8
2V27	-29C	-38A8	●	Adjustable Height Arm	1249	1285	1329	1400	1496	1591	1892	2103	2315	2527
		-39A8	●	Swing-Back Adjustable Height Arm	1275	1311	1355	1426	1522	1617	1918	2129	2341	2553
		-22A8	●	Adjustable Height Arm (Black)	1314	1349	1394	1465	1560	1656	1956	2168	2380	2592
		-23A8	●	Adjustable Height Arm (Chrome)	1314	1349	1394	1465	1560	1656	1956	2168	2380	2592
		-19A	○	Panel Arm Full Upholstered	1417	1452	1497	1567	1663	1759	2136	2347	2560	2772
		-80A	●	Executive "C" Arm Non-Upholstered	1371	1406	1451	1522	1617	1713	2014	2225	2437	2649
		-90A	○	Executive "C" Arm Full Upholstered	1440	1475	1520	1590	1686	1782	2127	2338	2550	2762

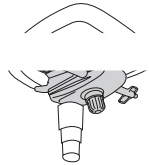

STANDARD ARM OPTIONS

-38A ● Height Adjustable

-39A ● Swing-Back Adjustable Height Arm

Adjustable Height Arm
-22A8 ● Black Upright
-23A8 ● Chrome Upright
For: COM Add - .5 yd., COL Add - 4 sq. ft.

Panel Arm
-19A ○ Full Upholstered
For: COM Add - .75 yd., COL Add - 15 sq. ft.

Executive "C" Arm
-80A ● Non-Upholstered
-90A ● Full Upholstered
For: COM Add - 1 yd., COL Add - 8 sq. ft.

How to Specify: SEAT
2V27-29C-90A-13AIR

SERIES | BACK | ARM STYLE | CONTROL | OPTION

Head Rest (Optional)
-2VHR ○ Full Upholstered* (See options)
For: COM Add - 1 yd., COL Add - 9.5 sq. ft.

STANDARD CHAIR OPTIONS

SUFFIX	QS	DESCRIPTION	PRICE	SUFFIX	QS	DESCRIPTION	PRICE
-9	●	Four Way Adjustable Arm Cap (22A, 23A)	\$31 List	-5UC	○	Upholstered Caps - Aluminum Arms	\$49 List
-13AIR	●	Air Lumbar	\$66 List	-2UC	○	Upholstered Caps - Adjustable Arms	\$49 List
-15SC	●	Hard Floor Casters	\$23 List	-11CB	○	Custom Stain Base (5 chair minimum)	\$223 List
-15GL	●	Glides	\$23 List	-2VHR	○	Full Function Head Rest	\$251 List
-15XC	●	Spoked Casters	\$33 List	-21TB133	○	Fire Rated Products (see page 11)	\$159 List
-11PB	●	Polished Aluminum Base	\$92 List	-30SS	●	Seat Slide (9C only)	\$73 List
-11BA	●	Brushed Aluminum Base	\$92 List				
-14AB	●	Adj. Width Bracket (22A, 23A only)	\$23 List				

VOSS - EXECUTIVE FULL SCALE MID BACK SHIPS STANDARD WITH:

- Black Base with Dual Wheel Black Carpet Casters
- Adjustable Height Back
- Articulating Head Rest (Optional)



FULL SCALE MID BACK / STANDARD SEAT
EXECUTIVE / CONFERENCE

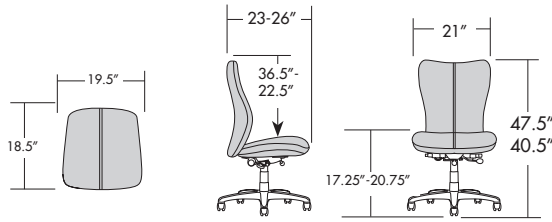

#1 STANDARD SEAT (A)
Arm Width Range 25"-31"

#7 FULL SCALE EXECUTIVE BACK
Seat & Back - COM 2 yd.; COL 24 sq. ft.

True 48-Hour Commitment

- **20/48** 20 Chairs Every 48 Hours
- **10/48** 10 Chairs Every 48 Hours

FULL SCALE MID BACK / STANDARD SEAT - Single Position Knee Tilt Control (WEIGHT CAPACITY 300 LBS)

MODEL	CONTROL	ARM	QS	DESCRIPTION (SEE BELOW)	A	B	1/COM	2	3/COL	4	5	6	7	8
2V17	-12C*	-38A8	●	Adjustable Height Arm	1113	1148	1193	1264	1359	1510	1756	1968	2179	2391
		-39A8	●	Swing-Back Adjustable Height Arm	1139	1174	1219	1290	1385	1536	1782	1994	2205	2417
		-22A8	●	Adjustable Height Arm (Black)	1177	1213	1257	1328	1424	1575	1820	2032	2243	2455
		-23A8	●	Adjustable Height Arm (Chrome)	1177	1213	1257	1328	1424	1575	1820	2032	2243	2455
		-19A	○	Panel Arm Full Upholstered	1280	1316	1360	1431	1527	1678	2000	2212	2423	2635
		-80A	●	Executive "C" Arm Non-Upholstered	1234	1270	1315	1385	1481	1632	1877	2089	2300	2513
		-90A	○	Executive "C" Arm Full Upholstered	1303	1338	1383	1454	1550	1700	1991	2203	2414	2626
	*-13C	For Seat Slider, Replace -12C with -13C			Add \$73 List		How to Specify: 2V17-13C-39A8							

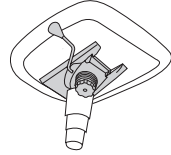

FULL SCALE MID BACK / STANDARD SEAT - Syncro Control with Side Tension Adjustment (WEIGHT CAPACITY 300 LBS)

MODEL	CONTROL	ARM	QS	DESCRIPTION (SEE BELOW)	A	B	1/COM	2	3/COL	4	5	6	7	8
2V17	-9C	-38A8	●	Adjustable Height Arm	1165	1200	1245	1316	1411	1562	1808	2020	2231	2443
		-39A8	●	Swing-Back Adjustable Height Arm	1191	1226	1271	1342	1437	1588	1834	2046	2257	2469
		-22A8	●	Adjustable Height Arm (Black)	1229	1265	1309	1380	1476	1627	1872	2084	2295	2507
		-23A8	●	Adjustable Height Arm (Chrome)	1229	1265	1309	1380	1476	1627	1872	2084	2295	2507
		-19A	○	Panel Arm Full Upholstered	1332	1368	1412	1483	1579	1730	2052	2264	2475	2687
		-80A	●	Executive "C" Arm Non-Upholstered	1286	1322	1367	1437	1533	1684	1929	2141	2352	2565
		-90A	○	Executive "C" Arm Full Upholstered	1355	1390	1435	1506	1602	1752	2043	2255	2466	2678

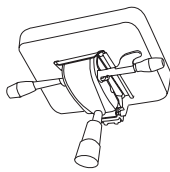

FULL SCALE MID BACK / STANDARD SEAT - Full Function Syncro Control / Seat Slider (WEIGHT CAPACITY 300 LBS)

MODEL	CONTROL	ARM	QS	DESCRIPTION (SEE BELOW)	A	B	1/COM	2	3/COL	4	5	6	7	8
2V17	-29C	-38A8	●	Adjustable Height Arm	1186	1221	1266	1337	1432	1583	1829	2041	2252	2464
		-39A8	●	Swing-Back Adjustable Height Arm	1212	1247	1292	1363	1458	1609	1855	2067	2278	2490
		-22A8	●	Adjustable Height Arm (Black)	1250	1286	1330	1401	1497	1648	1893	2105	2316	2528
		-23A8	●	Adjustable Height Arm (Chrome)	1250	1286	1330	1401	1497	1648	1893	2105	2316	2528
		-19A	○	Panel Arm Full Upholstered	1353	1389	1433	1504	1600	1751	2073	2285	2496	2708
		-80A	●	Executive "C" Arm Non-Upholstered	1307	1343	1388	1458	1554	1705	1950	2162	2373	2586
		-90A	○	Executive "C" Arm Full Upholstered	1376	1411	1456	1527	1623	1773	2064	2276	2487	2699

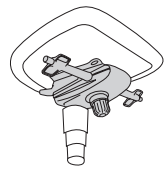

STANDARD ARM OPTIONS

-38A ● Height Adjustable

-39A ● Swing-Back Adjustable Height Arm

Adjustable Height Arm
-22A8 ● Black Upright
-23A8 ● Chrome Upright
For: COM Add - .5 yd.
COL Add - 4 sq. ft.

Panel Arm
-19A ○ Full Upholstered
For: COM Add - .75 yd.
COL Add - 15 sq. ft.

Executive "C" Arm
-80A ● Non-Upholstered
-90A ○ Full Upholstered
For: COM Add - 1 yd.
COL Add - 8 sq. ft.

Head Rest (Optional)
-2VHR ○ Full Upholstered* (See options)
For: COM Add - 1 yd.
COL Add - 9.5 sq. ft.

How to Specify: SEAT
2V17-29C-90A-13AIR
SERIES BACK | ARM STYLE | OPTION
CONTROL

STANDARD CHAIR OPTIONS

SUFFIX	QS	DESCRIPTION	PRICE	SUFFIX	QS	DESCRIPTION	PRICE
-9	●	Four Way Adjustable Arm Cap (22A, 23A)	\$31 List	-5UC	○	Upholstered Caps - Aluminum Arms	\$49 List
-13AIR	●	Air Lumbar	\$66 List	-2UC	○	Upholstered Caps - Adjustable Arms	\$49 List
-15SC	●	Hard Floor Casters	\$23 List	-11CB	○	Custom Stain Base (5 chair minimum)	\$223 List
-15GL	●	Glides	\$23 List	-2VHR	●	Full Function Head Rest	\$251 List
-15XC	●	Spoked Casters	\$33 List	-21TB133	○	Fire Rated Products (see page 11)	\$159 List
-11PB	●	Polished Aluminum Base	\$92 List	-30SS	●	Seat Slide (9C only)	\$73 List
-11BA	●	Brushed Aluminum Base	\$92 List				
-14AB	●	Adj. Width Bracket (22A, 23A only)	\$23 List				

VOSS - EXECUTIVE FULL SCALE MID BACK SHIPS STANDARD WITH:
 • Black Base with Dual Wheel Black Carpet Casters • Adjustable Height Back • Articulating Head Rest (Optional)

VOSS

MID SCALE HIGH BACK / LARGE SEAT

CONFERENCE

True 48-Hour Commitment

- **20/48** 20 Chairs Every 48 Hours
- **10/48** 10 Chairs Every 48 Hours

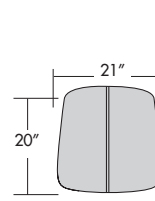

#3 LARGE SEAT (C)
Arm Width Range 25"-31"

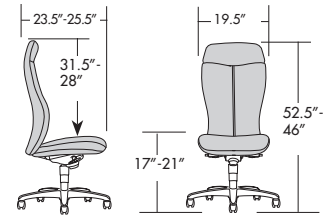

#5 MID SCALE HIGH BACK
Seat & Back with Headrest - COM 2.25 yd.; COL 23.5 sq. ft.

MID SCALE HIGH BACK / HEADREST / LARGE SEAT - Single Position Knee Tilt Control (WEIGHT CAPACITY 300 LBS)

MODEL	CONTROL	ARM	QS	DESCRIPTION (SEE BELOW)	A	B	1/COM	2	3/COL	4	5	6	7	8
2V35	-12C*	-38A8	●	Adjustable Height Arm	1312	1353	1404	1466	1567	1733	2003	2235	2468	2701
		-39A8	●	Swing-Back Adjustable Height Arm	1338	1379	1430	1492	1593	1759	2029	2261	2494	2727
		-22A8	●	Adjustable Height Arm (Black)	1377	1418	1468	1531	1632	1797	2068	2299	2532	2765
		-23A8	●	Adjustable Height Arm (Chrome)	1377	1418	1468	1531	1632	1797	2068	2299	2532	2765
		-19A	○	Panel Arm Full Upholstered	1480	1520	1571	1634	1735	1900	2247	2479	2712	2945
		-80A	●	Executive "C" Arm Non-Upholstered	1434	1475	1526	1588	1689	1854	2125	2357	2590	2823
		-90A	○	Executive "C" Arm Full Upholstered	1503	1543	1594	1657	1758	1923	2238	2470	2703	2936

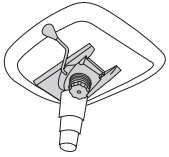

*-13C For Seat Slider, Replace -12C with -13C Add \$73 List How to Specify: 2V35-13C-39A8

MID SCALE HIGH BACK / HEADREST / LARGE SEAT - Syncro Control with Side Tension Adjustment (WEIGHT CAPACITY 300 LBS)

MODEL	CONTROL	ARM	QS	DESCRIPTION (SEE BELOW)	A	B	1/COM	2	3/COL	4	5	6	7	8
2V35	-9C	-38A8	●	Adjustable Height Arm	1364	1405	1456	1518	1619	1785	2055	2287	2520	2753
		-39A8	●	Swing-Back Adjustable Height Arm	1390	1431	1482	1544	1645	1811	2081	2313	2546	2779
		-22A8	●	Adjustable Height Arm (Black)	1429	1470	1520	1583	1684	1849	2120	2351	2584	2817
		-23A8	●	Adjustable Height Arm (Chrome)	1429	1470	1520	1583	1684	1849	2120	2351	2584	2817
		-19A	○	Panel Arm Full Upholstered	1532	1572	1623	1686	1787	1952	2299	2531	2764	2997
		-80A	●	Executive "C" Arm Non-Upholstered	1486	1527	1578	1640	1741	1906	2177	2409	2642	2875
		-90A	○	Executive "C" Arm Full Upholstered	1555	1595	1646	1709	1810	1975	2290	2522	2755	2988

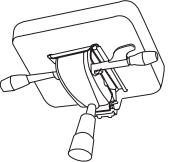

MID SCALE HIGH BACK/HEADREST/ LARGE SEAT - Full Function Syncro Control / Seat Slider (WEIGHT CAPACITY 300 LBS)

MODEL	CONTROL	ARM	QS	DESCRIPTION (SEE BELOW)	A	B	1/COM	2	3/COL	4	5	6	7	8
2V35	-29C	-38A8	●	Adjustable Height Arm	1385	1426	1477	1539	1640	1806	2076	2308	2541	2774
		-39A8	●	Swing-Back Adjustable Height Arm	1411	1452	1503	1565	1666	1832	2102	2334	2567	2800
		-22A8	●	Adjustable Height Arm (Black)	1450	1491	1541	1604	1705	1870	2141	2372	2605	2838
		-23A8	●	Adjustable Height Arm (Chrome)	1450	1491	1541	1604	1705	1870	2141	2372	2605	2838
		-19A	○	Panel Arm Full Upholstered	1553	1593	1644	1707	1808	1973	2320	2552	2785	3018
		-80A	●	Executive "C" Arm Non-Upholstered	1507	1548	1599	1661	1762	1927	2198	2430	2663	2896
		-90A	○	Executive "C" Arm Full Upholstered	1576	1616	1667	1730	1831	1996	2311	2543	2776	3009

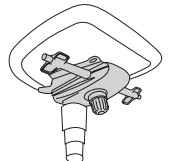

STANDARD ARM OPTIONS

-38A ● Height Adjustable

-39A ● Swing-Back Adjustable Height Arm

Adjustable Height Arm
-22A8 ● Black Upright
-23A8 ● Chrome Upright

For: COM Add - .5 yd.
COL Add - 4 sq. ft.

Panel Arm
-19A ○ Full Upholstered

For: COM Add - .75 yd.
COL Add - 15 sq. ft.

Executive "C" Arm
-80A ● Non-Upholstered
-90A ○ Full Upholstered

For: COM Add - 1 yd.
COL Add - 8 sq. ft.

How to Specify:

SEAT UPHOLSTERED ARM CAPS
2V35-29C-23A8-2UC-15XC

SERIES BACK | ARM STYLE | OPTION

CONTROL

STANDARD CHAIR OPTIONS

SUFFIX	QS DESCRIPTION	PRICE	SUFFIX	QS DESCRIPTION	PRICE
-9	● Four Way Adjustable Arm Cap (22A, 23A)	\$31 List	-2UC	○ Upholstered Caps - Adjustable Arms	\$49 List
-13AIR	● Air Lumbar	\$66 List	-11CB	○ Custom Stain Base (5 chair minimum)	\$223 List
-15SC	● Hard Floor Casters	\$23 List	-21TB133	○ Fire Rated Products (see page 11)	\$159 List
-15GL	● Glides	\$23 List	-30SS	● Seat Slide (9C only)	\$73 List
-15XC	● Spoked Casters	\$33 List			
-11PB	● Polished Aluminum Base	\$92 List			
-11BA	● Brushed Aluminum Base	\$92 List			
-14AB	● Adj. Width Bracket (22A, 23A only)	\$23 List			
-5UC	○ Upholstered Caps - Aluminum Arms	\$49 List			

**MID SCALE HIGH BACK / MEDIUM SEAT
CONFERENCE**

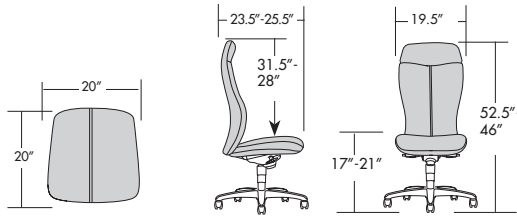

#2 MEDIUM SEAT
Arm Width Range 25"-31"

#5 MID SCALE HIGH BACK
Seat & Back with Headrest - COM 2.25 yd.; COL 23.5 sq. ft.

True 48-Hour Commitment

- **20/48** 20 Chairs Every 48 Hours
- **10/48** 10 Chairs Every 48 Hours

MID SCALE HIGH BACK / HEADREST / MEDIUM SEAT - Single Position Knee Tilt Control (WEIGHT CAPACITY 300 LBS)

MODEL	CONTROL	ARM	QS	DESCRIPTION (SEE BELOW)	A	B	1/COM	2	3/COL	4	5	6	7	8
2V25	-12C*	-38A8	●	Adjustable Height Arm	1240	1280	1331	1394	1494	1660	1930	2162	2395	2628
		-39A8	●	Swing-Back Adjustable Height Arm	1266	1306	1357	1420	1520	1686	1956	2188	2421	2654
		-22A8	●	Adjustable Height Arm (Black)	1304	1345	1396	1458	1559	1724	1995	2227	2460	2693
		-23A8	●	Adjustable Height Arm (Chrome)	1304	1345	1396	1458	1559	1724	1995	2227	2460	2693
		-19A	○	Panel Arm Full Upholstered	1407	1448	1499	1561	1662	1827	2175	2407	2640	2872
		-80A	●	Executive "C" Arm Non-Upholstered	1361	1402	1453	1515	1616	1782	2052	2284	2517	2750
		-90A	○	Executive "C" Arm Full Upholstered	1430	1471	1522	1584	1685	1850	2165	2397	2630	2863
	*-13C			For Seat Slider, Replace -12C with -13C			Add \$73 List							How to Specify: 2V25-13C-39A8

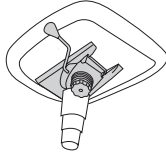

MID SCALE HIGH BACK / HEADREST / MEDIUM SEAT - Syncro Control with Side Tension Adjustment (WEIGHT CAPACITY 300 LBS)

MODEL	CONTROL	ARM	QS	DESCRIPTION (SEE BELOW)	A	B	1/COM	2	3/COL	4	5	6	7	8
2V25	-9C	-38A8	●	Adjustable Height Arm	1292	1332	1383	1446	1546	1712	1982	2214	2447	2680
		-39A8	●	Swing-Back Adjustable Height Arm	1318	1358	1409	1472	1572	1738	2008	2240	2473	2706
		-22A8	●	Adjustable Height Arm (Black)	1356	1397	1448	1510	1611	1776	2047	2279	2512	2745
		-23A8	●	Adjustable Height Arm (Chrome)	1356	1397	1448	1510	1611	1776	2047	2279	2512	2745
		-19A	○	Panel Arm Full Upholstered	1459	1500	1551	1613	1714	1879	2227	2459	2692	2924
		-80A	●	Executive "C" Arm Non-Upholstered	1413	1454	1505	1567	1668	1834	2104	2336	2569	2802
		-90A	○	Executive "C" Arm Full Upholstered	1482	1523	1574	1636	1737	1902	2217	2449	2682	2915

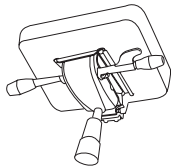

MID SCALE HIGH BACK/HEADREST/MEDIUM SEAT - Full Function Syncro Control / Seat Slider (WEIGHT CAPACITY 300 LBS)

MODEL	CONTROL	ARM	QS	DESCRIPTION (SEE BELOW)	A	B	1/COM	2	3/COL	4	5	6	7	8
2V25	-29C	-38A8	●	Adjustable Height Arm	1313	1353	1404	1467	1567	1733	2003	2235	2468	2701
		-39A8	●	Swing-Back Adjustable Height Arm	1339	1379	1430	1493	1593	1759	2029	2261	2494	2727
		-22A8	●	Adjustable Height Arm (Black)	1377	1418	1469	1531	1632	1797	2068	2300	2533	2766
		-23A8	●	Adjustable Height Arm (Chrome)	1377	1418	1469	1531	1632	1797	2068	2300	2533	2766
		-19A	○	Panel Arm Full Upholstered	1480	1521	1572	1634	1735	1900	2248	2480	2713	2945
		-80A	●	Executive "C" Arm Non-Upholstered	1434	1475	1526	1588	1689	1855	2125	2357	2590	2823
		-90A	○	Executive "C" Arm Full Upholstered	1503	1544	1595	1657	1758	1923	2238	2470	2703	2936

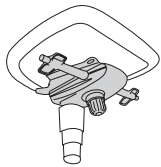

STANDARD ARM OPTIONS

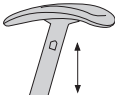

-38A ● Height Adjustable

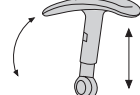

-39A ● Swing-Back Adjustable Height Arm



Adjustable Height Arm
-22A8 ● Black Upright
-23A8 ● Chrome Upright

For: COM Add - .5 yd.
COL Add - 4 sq. ft.

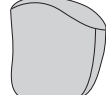

Panel Arm
-19A ○ Full Upholstered

For: COM Add - .75 yd.
COL Add - 15 sq. ft.



Executive "C" Arm
-80A ● Non-Upholstered
-90A ○ Full Upholstered

For: COM Add - 1 yd.
COL Add - 8 sq. ft.

How to Specify:

SEAT UPHOLSTERED ARM CAPS
2V25-29C-23A8-2UC-15XC

SERIES BACK | ARM STYLE | OPTION

CONTROL

STANDARD CHAIR OPTIONS

SUFFIX	QS DESCRIPTION	PRICE	SUFFIX	QS DESCRIPTION	PRICE
-9	● Four Way Adjustable Arm Cap (22A, 23A)	\$31 List	-2UC	○ Upholstered Caps - Adjustable Arms	\$49 List
-13AIR	● Air Lumbar	\$66 List	-11CB	○ Custom Stain Base (5 chair minimum)	\$223 List
-15SC	● Hard Floor Casters	\$23 List	-21TB133	○ Fire Rated Products (see page 11)	\$159 List
-15GL	● Glides	\$23 List	-30SS	● Seat Slide (9C only)	\$73 List
-15XC	● Spoked Casters	\$33 List			
-11PB	● Polished Aluminum Base	\$92 List			
-11BA	● Brushed Aluminum Base	\$92 List			
-14AB	● Adj. Width Bracket (22A, 23A only)	\$23 List			
-5UC	○ Upholstered Caps - Aluminum Arms	\$49 List			

MID SCALE MID BACK / LARGE SEAT
CONFERENCE / TASK

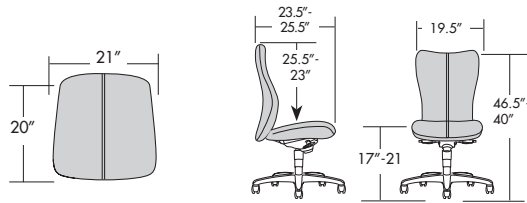

#3 LARGE SEAT (C)
Arm Width Range 25"-31"

#3 MID BACK
Seat & Back - COM 2 yd.; COL 21 sq. ft.

True 48-Hour Commitment

- **20/48** 20 Chairs Every 48 Hours
- **10/48** 10 Chairs Every 48 Hours

MID BACK / LARGE SEAT - Single Position Knee Tilt Control (WEIGHT CAPACITY 300 LBS)

MODEL	CONTROL	ARM	QS	DESCRIPTION (SEE BELOW)	A	B	1/COM	2	3/COL	4	5	6	7	8
2V33	-12C*	-OA	●	No Arms	853	886	925	987	1070	1198	1418	1603	1793	1978
		-38A8	●	Adjustable Height Arm	931	964	1003	1065	1148	1276	1496	1681	1871	2056
		-39A8	●	Swing-Back Adjustable Height Arm	957	990	1029	1091	1174	1302	1522	1707	1897	2082
		-22A8	●	Adjustable Height Arm (Black)	995	1029	1067	1129	1213	1341	1560	1745	1935	2121
		-23A8	●	Adjustable Height Arm (Chrome)	995	1029	1067	1129	1213	1341	1560	1745	1935	2121
		-19A	○	Panel Arm Full Upholstered	1098	1132	1170	1232	1316	1444	1740	1925	2115	2300
		-80A	●	Executive "C" Arm Non-Upholstered	1052	1086	1124	1187	1270	1398	1617	1802	1993	2178
		-90A	○	Executive "C" Arm Full Upholstered	1121	1154	1193	1255	1338	1466	1731	1916	2106	2291
		*-13C		For Seat Slider, Replace -12C with -13C	Add \$73 List		How to Specify: 2V33-13C-39A8							

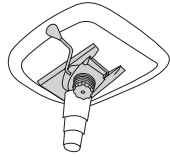

MID BACK / LARGE SEAT - Syncro Control with Side Tension Adjustment (WEIGHT CAPACITY 300 LBS)

MODEL	CONTROL	ARM	QS	DESCRIPTION (SEE BELOW)	A	B	1/COM	2	3/COL	4	5	6	7	8
2V33	-9C	-OA	●	No Arms	905	938	977	1039	1122	1250	1470	1655	1845	2030
		-38A8	●	Adjustable Height Arm	983	1016	1055	1117	1200	1328	1548	1733	1923	2108
		-39A8	●	Swing-Back Adjustable Height Arm	1009	1042	1081	1143	1226	1354	1574	1759	1949	2134
		-22A8	●	Adjustable Height Arm (Black)	1047	1081	1119	1181	1265	1393	1612	1797	1987	2173
		-23A8	●	Adjustable Height Arm (Chrome)	1047	1081	1119	1181	1265	1393	1612	1797	1987	2173
		-19A	○	Panel Arm Full Upholstered	1150	1184	1222	1284	1368	1496	1792	1977	2167	2352
		-80A	●	Executive "C" Arm Non-Upholstered	1104	1138	1176	1239	1322	1450	1669	1854	2045	2230
		-90A	○	Executive "C" Arm Full Upholstered	1173	1206	1245	1307	1390	1518	1783	1968	2158	2343

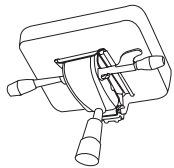

MID BACK / LARGE SEAT - Full Function Syncro Control / Seat Slider (WEIGHT CAPACITY 300 LBS)

MODEL	CONTROL	ARM	QS	DESCRIPTION (SEE BELOW)	A	B	1/COM	2	3/COL	4	5	6	7	8
2V33	-29C	-OA	●	No Arms	926	959	998	1060	1143	1271	1491	1676	1866	2051
		-38A8	●	Adjustable Height Arm	1004	1037	1076	1138	1221	1349	1569	1754	1944	2129
		-39A8	●	Swing-Back Adjustable Height Arm	1030	1063	1102	1164	1247	1375	1595	1780	1970	2155
		-22A8	●	Adjustable Height Arm (Black)	1068	1102	1140	1202	1286	1414	1633	1818	2008	2194
		-23A8	●	Adjustable Height Arm (Chrome)	1068	1102	1140	1202	1286	1414	1633	1818	2008	2194
		-19A	○	Panel Arm Full Upholstered	1171	1205	1243	1305	1389	1517	1813	1998	2188	2373
		-80A	●	Executive "C" Arm Non-Upholstered	1125	1159	1197	1260	1343	1471	1690	1875	2066	2251
		-90A	○	Executive "C" Arm Full Upholstered	1194	1227	1266	1328	1411	1539	1804	1989	2179	2364

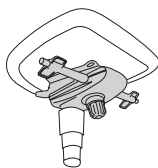

STANDARD ARM OPTIONS



-38A ● Height Adjustable



-39A ● Swing-Back Adjustable Height Arm



Adjustable Height Arm
-22A8 ● Black Upright
-23A8 ● Chrome Upright

For: COM Add - .5 yd.
COL Add - 4 sq. ft.



Panel Arm
-19A ○ Full Upholstered

For: COM Add - .75 yd.
COL Add - 15 sq. ft.



Executive "C" Arm
-80A ● Non-Upholstered
-90A ○ Full Upholstered

For: COM Add - 1 yd.
COL Add - 8 sq. ft.

How to Specify:

SEAT UPHOLSTERED ARM CAPS
2V33-29C-39A8-2UC-11BA

SERIES BACK | ARM STYLE | OPTION
CONTROL

STANDARD CHAIR OPTIONS

SUFFIX	QS DESCRIPTION	PRICE	SUFFIX	QS DESCRIPTION	PRICE
-9	● Four Way Adjustable Arm Cap (22A, 23A)	\$31 List	-2UC	○ Upholstered Caps - Adjustable Arms	\$49 List
-13AIR	● Air Lumbar	\$66 List	-11CB	○ Custom Stain Base (5 chair minimum)	\$223 List
-15SC	● Hard Floor Casters	\$23 List	-21TB133	○ Fire Rated Products (see page 11)	\$159 List
-15GL	● Glides	\$23 List	-30SS	● Seat Slide (9C only)	\$73 List
-15XC	● Spoked Casters	\$33 List			
-11PB	● Polished Aluminum Base	\$92 List			
-11BA	● Brushed Aluminum Base	\$92 List			
-14AB	● Adj. Width Bracket (22A, 23A only)	\$23 List			
-5UC	○ Upholstered Caps - Aluminum Arms	\$49 List			

VOSS

MID SCALE MID BACK / MEDIUM SEAT

CONFERENCE / TASK

True 48-Hour Commitment

● **20/48** 20 Chairs Every 48 Hours

○ **10/48** 10 Chairs Every 48 Hours

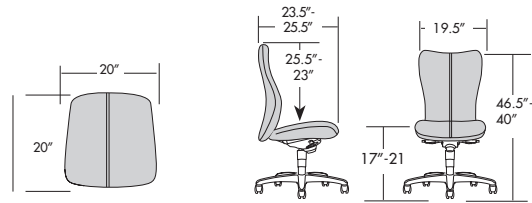

#2 MEDIUM SEAT
Arm Width Range 25"-31"

#3 MID BACK
Seat & Back - COM 2 yd.; COL 21 sq. ft.

MID BACK / MEDIUM SEAT - Single Position Knee Tilt Control (WEIGHT CAPACITY 275 LBS)

MODEL	CONTROL	ARM	QS	DESCRIPTION (SEE BELOW)	A	B	1/COM	2	3/COL	4	5	6	7	8
2V23	-12C*	-OA	●	No Arms	780	813	852	914	997	1125	1345	1530	1720	1905
		-38A8	●	Adjustable Height Arm	858	891	930	992	1075	1203	1423	1608	1798	1983
		-39A8	●	Swing-Back Adjustable Height Arm	884	917	956	1018	1101	1229	1449	1634	1824	2009
		-22A8	●	Adjustable Height Arm (Black)	922	956	994	1057	1140	1268	1487	1672	1863	2048
		-23A8	●	Adjustable Height Arm (Chrome)	922	956	994	1057	1140	1268	1487	1672	1863	2048
		-19A	○	Panel Arm Full Upholstered	1025	1059	1097	1160	1243	1371	1667	1852	2043	2228
		-80A	●	Executive "C" Arm Non-Upholstered	980	1013	1051	1114	1197	1325	1544	1730	1920	2105
		-90A	○	Executive "C" Arm Full Upholstered	1048	1082	1120	1182	1266	1394	1658	1843	2033	2218
*-13C For Seat Slider, Replace -12C with -13C					Add \$73 List			How to Specify: 2V23-13C-39A8						

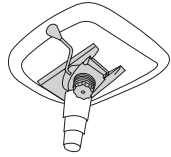

MID BACK / MEDIUM SEAT - Syncro Control with Side Tension Adjustment (WEIGHT CAPACITY 300 LBS)

MODEL	CONTROL	ARM	QS	DESCRIPTION (SEE BELOW)	A	B	1/COM	2	3/COL	4	5	6	7	8
2V23	-9C	-OA	●	No Arms	832	865	904	966	1049	1177	1397	1582	1772	1957
		-38A8	●	Adjustable Height Arm	910	943	982	1044	1127	1255	1475	1660	1850	2035
		-39A8	●	Swing-Back Adjustable Height Arm	936	969	1008	1070	1153	1281	1501	1686	1876	2061
		-22A8	●	Adjustable Height Arm (Black)	974	1008	1046	1109	1192	1320	1539	1724	1915	2100
		-23A8	●	Adjustable Height Arm (Chrome)	974	1008	1046	1109	1192	1320	1539	1724	1915	2100
		-19A	○	Panel Arm Full Upholstered	1077	1111	1149	1212	1295	1423	1719	1904	2095	2280
		-80A	●	Executive "C" Arm Non-Upholstered	1032	1065	1103	1166	1249	1377	1596	1782	1972	2157
		-90A	○	Executive "C" Arm Full Upholstered	1100	1134	1172	1234	1318	1446	1710	1895	2085	2270

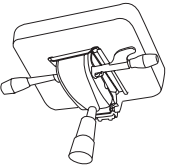

MID BACK / MEDIUM SEAT - Full Function Syncro Control / Seat Slider (WEIGHT CAPACITY 275 LBS)

MODEL	CONTROL	ARM	QS	DESCRIPTION (SEE BELOW)	A	B	1/COM	2	3/COL	4	5	6	7	8
2V23	-29C	-OA	●	No Arms	853	886	925	987	1070	1198	1418	1603	1793	1978
		-38A8	●	Adjustable Height Arm	931	964	1003	1065	1148	1276	1496	1681	1871	2056
		-39A8	●	Swing-Back Adjustable Height Arm	957	990	1029	1091	1174	1302	1522	1707	1897	2082
		-22A8	●	Adjustable Height Arm (Black)	995	1029	1067	1130	1213	1341	1560	1745	1936	2121
		-23A8	●	Adjustable Height Arm (Chrome)	995	1029	1067	1130	1213	1341	1560	1745	1936	2121
		-19A	○	Panel Arm Full Upholstered	1098	1132	1170	1233	1316	1444	1740	1925	2116	2301
		-80A	●	Executive "C" Arm Non-Upholstered	1053	1086	1124	1187	1270	1398	1617	1803	1993	2178
		-90A	○	Executive "C" Arm Full Upholstered	1121	1155	1193	1255	1339	1467	1731	1916	2106	2291

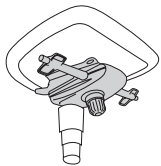

STANDARD ARM OPTIONS



-38A ● Height Adjustable



-39A ● Swing-Back Adjustable Height Arm



Adjustable Height Arm
-22A8 ● Black Upright
-23A8 ● Chrome Upright

For: COM Add - .5 yd.
COL Add - 4 sq. ft.



Panel Arm
-19A ○ Full Upholstered

For: COM Add - .75 yd.
COL Add - 15 sq. ft.



Executive "C" Arm
-80A ● Non-Upholstered
-90A ○ Full Upholstered

For: COM Add - 1 yd.
COL Add - 8 sq. ft.

How to Specify:

SEAT		UPHOLSTERED ARM CAPS	
2V23-29C-39A8-2UC-11BA			
SERIES	BACK	ARM STYLE	OPTION
	CONTROL		

STANDARD CHAIR OPTIONS

SUFFIX	QS DESCRIPTION	PRICE	SUFFIX	QS DESCRIPTION	PRICE
-9	● Four Way Adjustable Arm Cap (22A, 23A)	\$31 List	-2UC	○ Upholstered Caps - Adjustable Arms	\$49 List
-13AIR	● Air Lumbar	\$66 List	-11CB	○ Custom Stain Base (5 chair minimum)	\$223 List
-15SC	● Hard Floor Casters	\$23 List	-21TB133	○ Fire Rated Products (see page 11)	\$159 List
-15GL	● Glides	\$23 List	-30SS	● Seat Slide (9C only)	\$73 List
-15XC	● Spoked Casters	\$33 List			
-11PB	● Polished Aluminum Base	\$92 List			
-11BA	● Brushed Aluminum Base	\$92 List			
-14AB	● Adj. Width Bracket (22A, 23A only)	\$23 List			
-5UC	○ Upholstered Caps - Aluminum Arms	\$49 List			



MID SCALE MID BACK / STANDARD SEAT
CONFERENCE / TASK

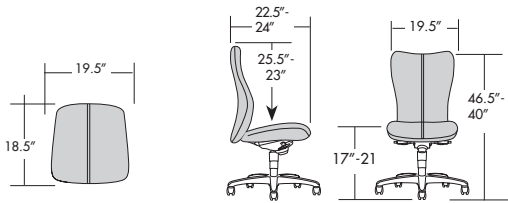

#1 STANDARD SEAT

Arm Width Range 25"-31"

#3 MID BACK

Seat & Back - COM 1.75 yd.; COL 20.75 sq. ft.

True 48-Hour Commitment

- **20/48** 20 Chairs Every 48 Hours
- **10/48** 10 Chairs Every 48 Hours

MID BACK / STANDARD SEAT - Single Position Knee Tilt Control (WEIGHT CAPACITY 275 LBS)

MODEL	CONTROL	ARM	QS	DESCRIPTION (SEE BELOW)	A	B	1/COM	2	3/COL	4	5	6	7	8
2V13	-12C*	-OA	●	No Arms	719	752	790	853	936	1064	1283	1468	1654	1839
		-38A8	●	Adjustable Height Arm	797	830	868	931	1014	1142	1361	1546	1732	1917
		-39A8	●	Swing-Back Adjustable Height Arm	823	856	894	957	1040	1168	1387	1572	1758	1943
		-22A8	●	Adjustable Height Arm (Black)	861	894	933	995	1078	1206	1426	1611	1796	1981
		-23A8	●	Adjustable Height Arm (Chrome)	861	894	933	995	1078	1206	1426	1611	1796	1981
		-19A	○	Panel Arm Full Upholstered	964	997	1036	1098	1181	1309	1606	1791	1976	2161
		-80A	●	Executive "C" Arm Non-Upholstered	918	952	990	1052	1136	1264	1483	1668	1853	2038
		-90A	○	Executive "C" Arm Full Upholstered	987	1020	1059	1121	1204	1332	1596	1782	1967	2152
		*-13C		For Seat Slider, Replace -12C with -13C	Add \$73 List		How to Specify: 2V13-13C-39A8							

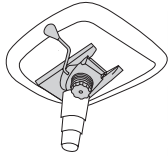

MID BACK / STANDARD SEAT - Syncro Control with Side Tension Adjustment (WEIGHT CAPACITY 300 LBS)

MODEL	CONTROL	ARM	QS	DESCRIPTION (SEE BELOW)	A	B	1/COM	2	3/COL	4	5	6	7	8
2V13	-9C	-OA	●	No Arms	771	804	842	905	988	1116	1335	1520	1706	1891
		-38A8	●	Adjustable Height Arm	849	882	920	983	1066	1194	1413	1598	1784	1969
		-39A8	●	Swing-Back Adjustable Height Arm	875	908	946	1009	1092	1220	1439	1624	1810	1995
		-22A8	●	Adjustable Height Arm (Black)	913	946	985	1047	1130	1258	1478	1663	1848	2033
		-23A8	●	Adjustable Height Arm (Chrome)	913	946	985	1047	1130	1258	1478	1663	1848	2033
		-19A	○	Panel Arm Full Upholstered	1016	1049	1088	1150	1233	1361	1658	1843	2028	2213
		-80A	●	Executive "C" Arm Non-Upholstered	970	1004	1042	1104	1188	1316	1535	1720	1905	2090
		-90A	○	Executive "C" Arm Full Upholstered	1039	1072	1111	1173	1256	1384	1648	1834	2019	2204

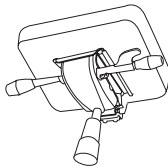

MID BACK / STANDARD SEAT - Full Function Syncro Control / Seat Slider (WEIGHT CAPACITY 275 LBS)

MODEL	CONTROL	ARM	QS	DESCRIPTION (SEE BELOW)	A	B	1/COM	2	3/COL	4	5	6	7	8
2V13	-29C	-OA	●	No Arms	792	825	863	926	1009	1137	1356	1541	1727	1912
		-38A8	●	Adjustable Height Arm	870	903	941	1004	1087	1215	1434	1619	1805	1990
		-39A8	●	Swing-Back Adjustable Height Arm	896	929	967	1030	1113	1241	1460	1645	1831	2016
		-22A8	●	Adjustable Height Arm (Black)	934	967	1006	1068	1151	1279	1499	1684	1869	2054
		-23A8	●	Adjustable Height Arm (Chrome)	934	967	1006	1068	1151	1279	1499	1684	1869	2054
		-19A	○	Panel Arm Full Upholstered	1037	1070	1109	1171	1254	1382	1679	1864	2049	2234
		-80A	●	Executive "C" Arm Non-Upholstered	991	1025	1063	1125	1209	1337	1556	1741	1926	2111
		-90A	○	Executive "C" Arm Full Upholstered	1060	1093	1132	1194	1277	1405	1669	1855	2040	2225

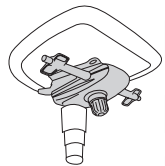

STANDARD ARM OPTIONS



-38A ● Height Adjustable



-39A ● Swing-Back Adjustable Height Arm



Adjustable Height Arm
-22A8 ● Black Upright
-23A8 ● Chrome Upright

For: COM Add - .5 yd.
COL Add - 4 sq. ft.



Panel Arm
-19A ○ Full Upholstered

For: COM Add - .75 yd.
COL Add - 15 sq. ft.



Executive "C" Arm
-80A ● Non-Upholstered
-90A ○ Full Upholstered

For: COM Add - 1 yd.
COL Add - 8 sq. ft.

How to Specify:

SEAT UPHOLSTERED ARM CAPS

2V13-29C-22A8-2UC-15SC

SERIES BACK | ARM STYLE | OPTION

CONTROL

STANDARD CHAIR OPTIONS

SUFFIX	QS DESCRIPTION	PRICE	SUFFIX	QS DESCRIPTION	PRICE
-9	● Four Way Adjustable Arm Cap (22A, 23A)	\$31 List	-2UC	○ Upholstered Caps - Adjustable Arms	\$49 List
-13AIR	● Air Lumbar	\$66 List	-11CB	○ Custom Stain Base (5 chair minimum)	\$223 List
-15SC	● Hard Floor Casters	\$23 List	-21TB133	○ Fire Rated Products (see page 11)	\$159 List
-15GL	● Glides	\$23 List	-30SS	● Seat Slide (9C only)	\$73 List
-15XC	● Spoked Casters	\$33 List			
-11PB	● Polished Aluminum Base	\$92 List			
-11BA	● Brushed Aluminum Base	\$92 List			
-14AB	● Adj. Width Bracket (22A, 23A only)	\$23 List			
-5UC	○ Upholstered Caps - Aluminum Arms	\$49 List			

VOSS

HIGH BACK MESH / LARGE SEAT

CONFERENCE

True 48-Hour Commitment

- **20/48** 20 Chairs Every 48 Hours
- **10/48** 10 Chairs Every 48 Hours

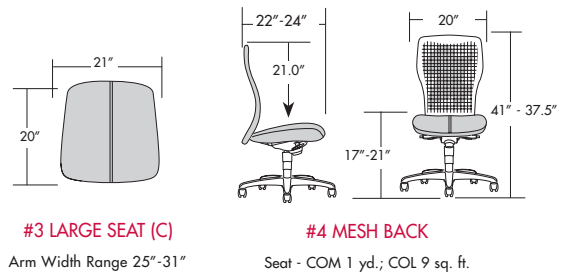

#3 LARGE SEAT (C)
Arm Width Range 25"-31"

#4 MESH BACK
Seat - COM 1 yd.; COL 9 sq. ft.

HIGH BACK MESH / LARGE SEAT - *Single Position Knee Tilt Control* (WEIGHT CAPACITY 300 LBS)

MODEL	CONTROL	ARM	QS	DESCRIPTION (SEE BELOW)	A	B	1/COM	2	3/COL	4	5	6	7	8
2V34	-12C*	-0A	●	No Arms	796	812	832	863	907	975	1085	1181	1276	1371
		-38A8	●	Adjustable Height Arm (Black)	874	890	910	941	985	1053	1163	1259	1354	1449
		-39A8	●	Adjustable Height Arm (Chrome)	900	916	936	967	1011	1079	1189	1285	1380	1475
		-22A8	●	Aluminum Arm (Brushed)	938	955	975	1006	1050	1117	1227	1323	1419	1513
		-23A8	●	Aluminum Arm (Polished)	938	955	975	1006	1050	1117	1227	1323	1419	1513
		-80A	●	Executive "C" Arm Non-Upholstered	995	1011	1031	1062	1106	1174	1284	1380	1475	1570
		-90A	●	Executive "C" Arm Upholstered	1064	1080	1101	1131	1175	1243	1398	1495	1589	1684

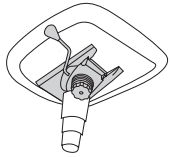

HIGH BACK MESH / LARGE SEAT - *Syncro Control* (WEIGHT CAPACITY 300 LBS)

MODEL	CONTROL	ARM	QS	DESCRIPTION (SEE BELOW)	A	B	1/COM	2	3/COL	4	5	6	7	8
2V34	-60C	-0A	●	No Arms	796	812	832	863	907	975	1085	1181	1276	1371
		-38A8	●	Adjustable Height Arm (Black)	874	890	910	941	985	1053	1163	1259	1354	1449
		-39A8	●	Adjustable Height Arm (Chrome)	900	916	936	967	1011	1079	1189	1285	1380	1475
		-22A8	●	Aluminum Arm (Brushed)	938	955	975	1006	1050	1117	1227	1323	1419	1513
		-23A8	●	Aluminum Arm (Polished)	938	955	975	1006	1050	1117	1227	1323	1419	1513
		-80A	●	Executive "C" Arm Non-Upholstered	995	1011	1031	1062	1106	1174	1284	1380	1475	1570
		-90A	●	Executive "C" Arm Upholstered	1064	1080	1101	1131	1175	1243	1398	1495	1589	1684

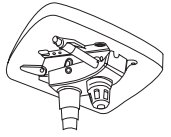

HIGH BACK MESH / LARGE SEAT - *Syncro Control with Side Tension Adjustment* (WEIGHT CAPACITY 300 LBS)

MODEL	CONTROL	ARM	QS	DESCRIPTION (SEE BELOW)	A	B	1/COM	2	3/COL	4	5	6	7	8
2V34	-9C	-0A	●	No Arms	848	864	884	915	959	1027	1137	1233	1328	1423
		-38A8	●	Adjustable Height Arm (Black)	926	942	962	993	1037	1105	1215	1311	1406	1501
		-39A8	●	Adjustable Height Arm (Chrome)	952	968	988	1019	1063	1131	1241	1337	1432	1527
		-22A8	●	Aluminum Arm (Brushed)	990	1007	1027	1058	1102	1169	1279	1375	1471	1565
		-23A8	●	Aluminum Arm (Polished)	990	1007	1027	1058	1102	1169	1279	1375	1471	1565
		-80A	●	Executive "C" Arm Non-Upholstered	1047	1063	1083	1114	1158	1226	1336	1432	1527	1622
		-90A	●	Executive "C" Arm Upholstered	1116	1132	1153	1183	1227	1295	1450	1547	1641	1736

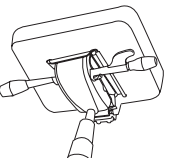

STANDARD ARM OPTIONS

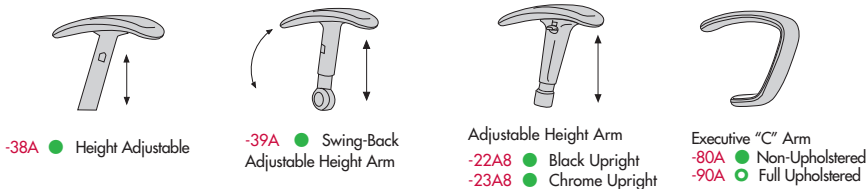

Seat Slide Option for the -12C

*-13C Seat Slide
For Seat Slider, Replace -12C with -13C Add \$70 List
How to Specify: 2V34-13C-39A8

For: COM Add - 1 yd.
COL Add - 8 sq. ft.

STANDARD CHAIR OPTIONS

SUFFIX	QS DESCRIPTION	PRICE
-9	● Four Way Adjustable Arm Cap (22A, 23A)	\$31 List
-15SC	● Hard Floor Casters	\$23 List
-15GL	● Glides	\$23 List
-15XC	● Spoked Casters	\$33 List
-11PB	● Polished Aluminum Base	\$92 List
-11BA	● Brushed Aluminum Base	\$92 List
-14AB	● Adj. Width Bracket (22A, 23A only)	\$23 List
-11CB	○ Custom Stain Base (5 chair minimum)	\$223 List
-21TB133	○ Fire Rated Products (see page 11)	\$92 List
-30SS	● Seat Slide (9C only)	\$73 List

MESH COLORS AVAILABLE

SUFFIX	QS DESCRIPTION	PRICE
-11-HM	● Black Mesh	\$0 List
-13-HM	● Graphite Mesh	\$21 List
-15-HM	● Doe Mesh	\$21 List
-17-HM	● Sea Foam Mesh	\$21 List

How to Specify:
SEAT
2V34-60C-38A-11PB-11-HM
SERIES | BACK | ARM STYLE | OPTION | MESH
CONTROL



**HIGH BACK MESH / MEDIUM SEAT
CONFERENCE**

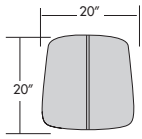

#2 MEDIUM SEAT
Arm Width Range 25"-31"

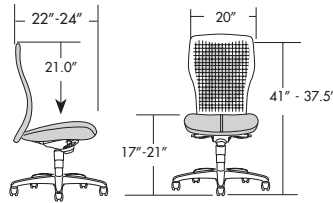

#4 MESH BACK
Seat - COM 1 yd.; COL 8.5 sq. ft.

True 48-Hour Commitment

- **20/48** 20 Chairs Every 48 Hours (Selected Models & Options Only)
- **10/48** 10 Chairs Every 48 Hours (Selected Models & Options Only)

HIGH MESH BACK / MEDIUM SEAT - Single Position Knee Tilt Control (WEIGHT CAPACITY 275 LBS)

MODEL	CONTROL	ARM	QS	DESCRIPTION (SEE BELOW)	A	B	1/COM	2	3/COL	4	5	6	7	8
2V24	-12C*	-0A	●	No Arms	723	739	759	790	834	902	1012	1108	1203	1298
		-38A8	●	Adjustable Height Arm	801	817	837	868	912	980	1090	1186	1281	1376
		-39A8	●	Swing-Back Adjustable Height Arm	827	843	863	894	938	1006	1116	1212	1307	1402
		-22A8	●	Adjustable Height Arm (Black)	865	882	902	933	977	1044	1154	1250	1346	1440
		-23A8	●	Adjustable Height Arm (Chrome)	865	882	902	933	977	1044	1154	1250	1346	1440

*-13C For Seat Slider, Replace -12C with -13C Add \$73 List How to Specify: **2V24-13C-39A8**

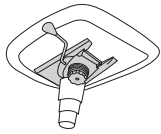

HIGH MESH BACK / MEDIUM SEAT - Syncro Control (WEIGHT CAPACITY 300 LBS)

MODEL	CONTROL	ARM	QS	DESCRIPTION (SEE BELOW)	A	B	1/COM	2	3/COL	4	5	6	7	8
2V24	-60C	-0A	●	No Arms	723	739	759	790	834	902	1012	1108	1203	1298
		-38A8	●	Adjustable Height Arm	801	817	837	868	912	980	1090	1186	1281	1376
		-39A8	●	Swing-Back Adjustable Height Arm	827	843	863	894	938	1006	1116	1212	1307	1402
		-22A8	●	Adjustable Height Arm (Black)	865	882	902	933	977	1044	1154	1250	1346	1440
		-23A8	●	Adjustable Height Arm (Chrome)	865	882	902	933	977	1044	1154	1250	1346	1440

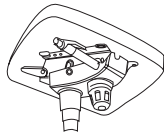

HIGH MESH BACK / MEDIUM SEAT - Syncro Control with Side Tension Adjustment (WEIGHT CAPACITY 300 LBS)

MODEL	CONTROL	ARM	QS	DESCRIPTION (SEE BELOW)	A	B	1/COM	2	3/COL	4	5	6	7	8
2V24	-9C	-0A	●	No Arms	775	791	811	842	886	954	1064	1160	1255	1350
		-38A8	●	Adjustable Height Arm	853	869	889	920	964	1032	1142	1238	1333	1428
		-39A8	●	Swing-Back Adjustable Height Arm	879	895	915	946	990	1058	1168	1264	1359	1454
		-22A8	●	Adjustable Height Arm (Black)	917	934	954	985	1029	1096	1206	1302	1398	1492
		-23A8	●	Adjustable Height Arm (Chrome)	917	934	954	985	1029	1096	1206	1302	1398	1492

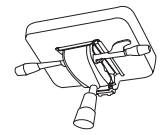

STANDARD ARM OPTIONS

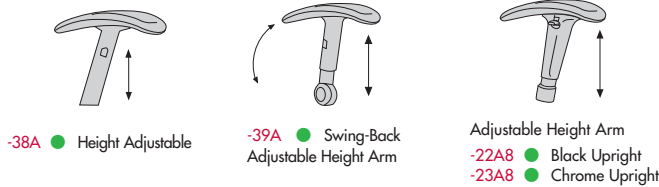

How to Specify:
2V24-9C-39A-15XC-01-HM
SERIES | BACK | CONTROL | ARM | STYLE | OPTION | MESH

STANDARD CHAIR OPTIONS

SUFFIX	QS DESCRIPTION	PRICE
-9	● Four Way Adjustable Arm Cap (22A, 23A)	\$31 List
-15SC	● Hard Floor Casters	\$23 List
-15GL	● Glides	\$23 List
-15XC	● Spoked Casters	\$33 List
-11PB	● Polished Aluminum Base	\$92 List
-11BA	● Brushed Aluminum Base	\$92 List
-14AB	● Adj. Width Bracket (22A, 23A only)	\$23 List
-11CB	● Custom Stain Base (5 chair minimum)	\$223 List
-21TB133	● Fire Rated Products (see page 11)	\$92 List
-30SS	● Seat Slide (9C only)	\$73 List

MESH COLORS AVAILABLE

SUFFIX	QS DESCRIPTION	PRICE
-11-HM	● Black Mesh	\$0 List
-13-HM	● Graphite Mesh	\$21 List
-15-HM	● Doe Mesh	\$21 List
-17-HM	● Sea Foam Mesh	\$21 List

VOSS

HIGH BACK MESH / STANDARD SEAT

CONFERENCE

True 48-Hour Commitment

- **20/48** 20 Chairs Every 48 Hours
- **10/48** 10 Chairs Every 48 Hours

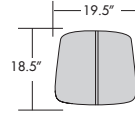

#1 STANDARD SEAT
Arm Width Range 25"-31"

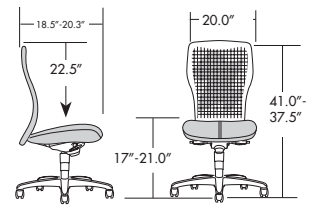

#4 MESH BACK
Seat - COM 1 yd.; COL 8 sq. ft.

HIGH MESH BACK / STANDARD SEAT - Single Position Knee Tilt Control (WEIGHT CAPACITY 275 LBS)

MODEL	CONTROL	ARM	QS	DESCRIPTION (SEE BELOW)	A	B	1/COM	2	3/COL	4	5	6	7	8
2V14	-12C*	-0A	●	No Arms	677	694	713	745	788	856	966	1062	1158	1252
		-38A8	●	Adjustable Height Arm	755	772	791	823	866	934	1044	1140	1236	1330
		-39A8	●	Swing-Back Adjustable Height Arm	781	798	817	849	892	960	1070	1166	1262	1356
		-22A8	●	Adjustable Height Arm (Black)	820	836	856	887	931	998	1109	1204	1300	1395
		-23A8	●	Adjustable Height Arm (Chrome)	820	836	856	887	931	998	1109	1204	1300	1395

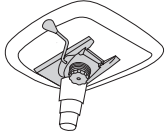

*-13C For Seat Slider, Replace -12C with -13C Add \$73 List How to Specify: 2V14-13C-39A8

HIGH MESH BACK / STANDARD SEAT - Syncro Control (WEIGHT CAPACITY 300 LBS)

MODEL	CONTROL	ARM	QS	DESCRIPTION (SEE BELOW)	A	B	1/COM	2	3/COL	4	5	6	7	8
2V14	-60C	-0A	●	No Arms	677	694	713	745	788	856	966	1062	1158	1252
		-38A8	●	Adjustable Height Arm	755	772	791	823	866	934	1044	1140	1236	1330
		-39A8	●	Swing-Back Adjustable Height Arm	781	798	817	849	892	960	1070	1166	1262	1356
		-22A8	●	Adjustable Height Arm (Black)	820	836	856	887	931	998	1109	1204	1300	1395
		-23A8	●	Adjustable Height Arm (Chrome)	820	836	856	887	931	998	1109	1204	1300	1395

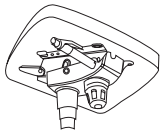

HIGH MESH BACK / STANDARD SEAT - Syncro Control with Side Tension Adjustment (WEIGHT CAPACITY 300 LBS)

MODEL	CONTROL	ARM	QS	DESCRIPTION (SEE BELOW)	A	B	1/COM	2	3/COL	4	5	6	7	8
2V14	-9C	-0A	●	No Arms	729	746	765	797	840	908	1018	1114	1210	1304
		-38A8	●	Adjustable Height Arm	807	824	843	875	918	986	1096	1192	1288	1382
		-39A8	●	Swing-Back Adjustable Height Arm	833	850	869	901	944	1012	1122	1218	1314	1408
		-22A8	●	Adjustable Height Arm (Black)	872	888	908	939	983	1050	1161	1256	1352	1447
		-23A8	●	Adjustable Height Arm (Chrome)	872	888	908	939	983	1050	1161	1256	1352	1447

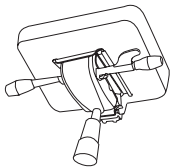

STANDARD ARM OPTIONS

-38A ● Height Adjustable

-39A ● Swing-Back Adjustable Height Arm

Adjustable Height Arm
-22A8 ● Black Upright
-23A8 ● Chrome Upright

How to Specify:

SEAT
2V14-9C-39A8-15XC-01-HM
SERIES BACK | ARM STYLE | OPTION MESH
CONTROL

STANDARD CHAIR OPTIONS

SUFFIX	QS DESCRIPTION	PRICE
-9	● Four Way Adjustable Arm Cap (22A, 23A)	\$31 List
-15SC	● Hard Floor Casters	\$23 List
-15GL	● Glides	\$23 List
-15XC	● Spoked Casters	\$33 List
-11PB	● Polished Aluminum Base	\$92 List
-11BA	● Brushed Aluminum Base	\$92 List
-14AB	● Adj. Width Bracket (22A, 23A only)	\$23 List
-11CB	● Custom Stain Base (5 chair minimum)	\$223 List
-21TB133	● Fire Rated Products (see page 11)	\$92 List
-30SS	● Seat Slide (9C only)	\$73 List
-11DR	● Drafting Stool kit - footing	\$126 List

MESH COLORS AVAILABLE

SUFFIX	QS DESCRIPTION	PRICE
-11-HM	● Black Mesh	\$0 List
-13-HM	● Graphite Mesh	\$21 List
-15-HM	● Doe Mesh	\$21 List
-17-HM	● Sea Foam Mesh	\$21 List



MID BACK MESH / LARGE SEAT
MESH WITH RATCHET BACK ADJUSTMENT

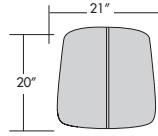

#3 LARGE SEAT (C)
Arm Width Range 25"-31"

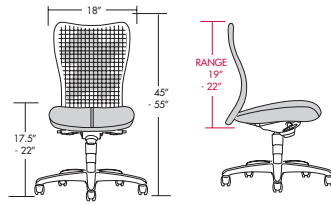

Seat - COM 1 yd.; COL 8.5 sq. ft.

True 48-Hour Commitment

- **20/48** 20 Chairs Every 48 Hours
- **10/48** 10 Chairs Every 48 Hours

MID BACK MESH / LARGE (C) SEAT - Knee Tilt Control (WEIGHT CAPACITY 300 LBS)

MODEL	CONTROL	ARM	QS	DESCRIPTION (SEE BELOW)	A	B	1/COM	2	3/COL	4	5	6	7	8
2R32	-12C	-0A	●	No Arms	748	764	784	816	859	927	1038	1133	1228	1323
		-38A8	●	Adjustable Height Arm	826	842	862	894	937	1005	1116	1211	1306	1401
		-39A8	●	Swing-Back Adjustable Height Arm	852	868	888	920	963	1031	1142	1237	1332	1427
		-22A8	●	Adjustable Height Black	890	907	927	959	1002	1069	1180	1275	1371	1465
		-23A8	●	Adjustable Height Chrome	890	907	927	959	1002	1069	1180	1275	1371	1465

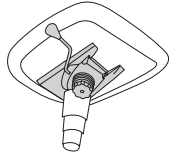

*-13C For Seat Slider, Replace -12C with -13C Add \$73 List How to Specify: **2R32-13C-39A8**

MID BACK MESH / LARGE (C) SEAT - Syncro Control (WEIGHT CAPACITY 300 LBS)

MODEL	CONTROL	ARM	QS	DESCRIPTION (SEE BELOW)	A	B	1/COM	2	3/COL	4	5	6	7	8
2R32	-60C	-0A	●	No Arms	748	764	784	816	859	927	1038	1133	1228	1323
		-38A8	●	Adjustable Height Arm	826	842	862	894	937	1005	1116	1211	1306	1401
		-39A8	●	Swing-Back Adjustable Height Arm	852	868	888	920	963	1031	1142	1237	1332	1427
		-22A8	●	Adjustable Height Arm (Black)*	890	907	927	959	1002	1069	1180	1275	1371	1465
		-23A8	●	Adjustable Height Arm (Chrome)	890	907	927	959	1002	1069	1180	1275	1371	1465

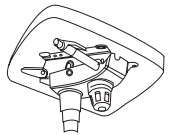

MID BACK MESH / LARGE (C) SEAT - Syncro Control with Side Tension Adjustment (WEIGHT CAPACITY 300 LBS)

MODEL	CONTROL	ARM	QS	DESCRIPTION (SEE BELOW)	A	B	1/COM	2	3/COL	4	5	6	7	8
2R32	-9C	-0A	●	No Arms	800	816	836	868	911	979	1090	1185	1280	1375
		-38A8	●	Adjustable Height Arm	878	894	914	946	989	1057	1168	1263	1358	1453
		-39A8	●	Swing-Back Adjustable Height Arm	904	920	940	972	1015	1083	1194	1289	1384	1479
		-22A8	●	Adjustable Height Black	942	959	979	1011	1054	1121	1232	1327	1423	1517
		-23A8	●	Adjustable Height Chrome	942	959	979	1011	1054	1121	1232	1327	1423	1517

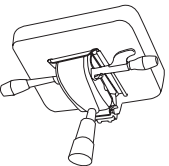

STANDARD ARM OPTIONS

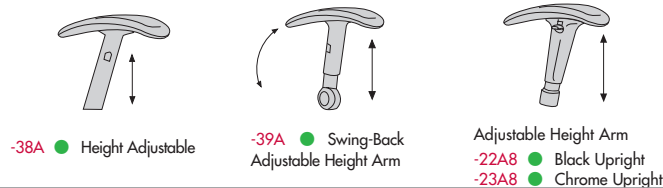

How to Specify:
2R32-9C-39A8-15XC
SEAT | SERIES | BACK | CONTROL | ARM | STYLE | OPTION

STANDARD CHAIR OPTIONS

SUFFIX	QS	DESCRIPTION	PRICE
-9	●	Four Way Adjustable Arm Cap (22A, 23A)	\$31 List
-155C	●	Hard Floor Casters	\$23 List
-15GL	●	Glides	\$23 List
-15XC	●	Spoked Casters	\$33 List
-11PB	●	Polished Aluminum Base	\$92 List
-11BA	●	Brushed Aluminum Base	\$92 List
-14AB	●	Adj. Width Bracket (22A, 23A only)	\$23 List
-11CB	○	Custom Stain Base (5 chair minimum)	\$223 List
-21TB133	○	Fire Rated Products (see page 11)	\$92 List
-30SS	●	Seat Slide (9C only)	\$73 List

MESH COLORS AVAILABLE

SUFFIX	QS	DESCRIPTION	PRICE
-01-MM	●	Black Mesh	\$0 List
-03-MM	●	Graphite Mesh	\$21 List
-05-MM	●	Doe Mesh	\$21 List
-07-MM	●	Sea Foam Mesh	\$21 List

VOSS

MID BACK MESH / MEDIUM SEAT

MESH WITH RATCHET BACK ADJUSTMENT

True 48-Hour Commitment

● **20/48** 20 Chairs Every 48 Hours

○ **10/48** 10 Chairs Every 48 Hours

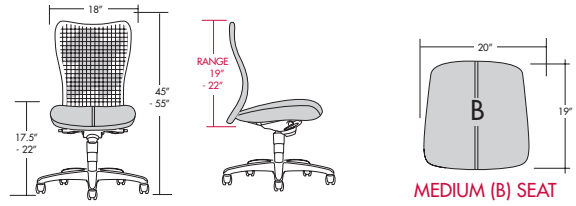

Seat - COM 1 yd.; COL 8.5 sq. ft.

MEDIUM (B) SEAT

MID BACK MESH / MEDIUM (B) SEAT - *Knee Tilt Control* (WEIGHT CAPACITY 300 LBS)

MODEL	CONTROL	ARM	QS	DESCRIPTION (SEE BELOW)	A	B	1/COM	2	3/COL	4	5	6	7	8
2R22	-12C	-0A	●	No Arms	675	692	711	744	786	854	965	1060	1155	1250
		-38A8	●	Adjustable Height Arm	753	770	789	822	864	932	1043	1138	1233	1328
		-39A8	●	Swing-Back Adjustable Height Arm	779	796	815	848	890	958	1069	1164	1259	1354
		-22A8	●	Adjustable Height Black	817	834	854	886	929	996	1108	1202	1298	1393
		-23A8	●	Adjustable Height Chrome	817	834	854	886	929	996	1108	1202	1298	1393

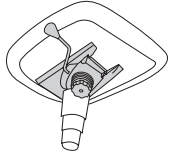

*-13C For Seat Slider, Replace -12C with -13C

Add \$73 List

How to Specify: **2R22-13C-39A8**

MID BACK MESH / MEDIUM (B) SEAT - *Syncro Control* (WEIGHT CAPACITY 300 LBS)

MODEL	CONTROL	ARM	QS	DESCRIPTION (SEE BELOW)	A	B	1/COM	2	3/COL	4	5	6	7	8
2R22	-60C	-0A	●	No Arms	675	692	711	744	786	854	965	1060	1155	1250
		-38A8	●	Adjustable Height Arm	753	770	789	822	864	932	1043	1138	1233	1328
		-39A8	●	Swing-Back Adjustable Height Arm	779	796	815	848	890	958	1069	1164	1259	1354
		-22A8	●	Adjustable Height Arm (Black)*	817	834	854	886	929	996	1108	1202	1298	1393
		-23A8	●	Adjustable Height Arm (Chrome)	817	834	854	886	929	996	1108	1202	1298	1393

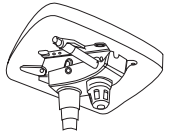

MID BACK MESH / MEDIUM (B) SEAT - *Syncro Control with Side Tension Adjustment* (WEIGHT CAPACITY 300 LBS)

MODEL	CONTROL	ARM	QS	DESCRIPTION (SEE BELOW)	A	B	1/COM	2	3/COL	4	5	6	7	8
2R22	-9C	-0A	●	No Arms	727	744	763	796	838	906	1017	1112	1207	1302
		-38A8	●	Adjustable Height Arm	805	822	841	874	916	984	1095	1190	1285	1380
		-39A8	●	Swing-Back Adjustable Height Arm	831	848	867	900	942	1010	1121	1216	1311	1406
		-22A8	●	Adjustable Height Black	869	886	906	938	981	1048	1160	1254	1350	1445
		-23A8	●	Adjustable Height Chrome	869	886	906	938	981	1048	1160	1254	1350	1445

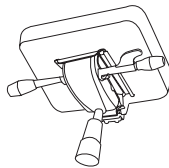

STANDARD ARM OPTIONS

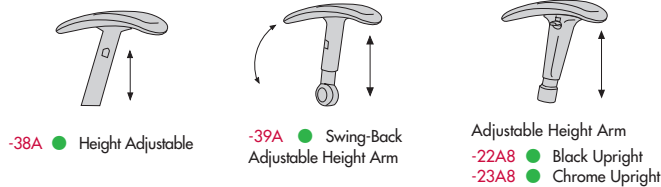

-38A ● Height Adjustable

-39A ● Swing-Back Adjustable Height Arm

Adjustable Height Arm
-22A8 ● Black Upright
-23A8 ● Chrome Upright

How to Specify:

SEAT
2R22-60C-39A8-15XC
SERIES BACK | ARM STYLE | CONTROL | OPTION

STANDARD CHAIR OPTIONS

SUFFIX	QS DESCRIPTION	PRICE
-9	● Four Way Adjustable Arm Cap (22A, 23A)	\$31 List
-155C	● Hard Floor Casters	\$23 List
-15GL	● Glides	\$23 List
-15XC	● Spoked Casters	\$33 List
-11PB	● Polished Aluminum Base	\$92 List
-11BA	● Brushed Aluminum Base	\$92 List
-14AB	● Adj. Width Bracket (22A, 23A only)	\$23 List
-11CB	● Custom Stain Base (5 chair minimum)	\$223 List
-21TB133	● Fire Rated Products (see page 11)	\$92 List
-30SS	● Seat Slide (9C only)	\$73 List
-11DR	● Drafting Stool kit - footing	\$126 List

MESH COLORS AVAILABLE

SUFFIX	QS DESCRIPTION	PRICE
-01-HM	● Black Mesh	\$0 List
-03-HM	● Graphite Mesh	\$21 List
-05-HM	● Doe Mesh	\$21 List
-07-HM	● Sea Foam Mesh	\$21 List



MID BACK MESH / STANDARD SEAT
MESH WITH RATCHET BACK ADJUSTMENT

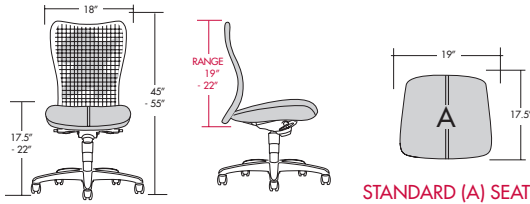

Seat - COM 1 yd.; COL 8 sq. ft.

True 48-Hour Commitment

- **20/48** 20 Chairs Every 48 Hours
- **10/48** 10 Chairs Every 48 Hours

MID BACK MESH / STANDARD (A) SEAT - Knee Tilt Control (WEIGHT CAPACITY 300 LBS)

MODEL	CONTROL	ARM	QS	DESCRIPTION (SEE BELOW)	A	B	1/COM	2	3/COL	4	5	6	7	8
2R12	-12C	-0A	●	No Arms	629	646	666	698	740	808	919	1014	1110	1204
		-38A8	●	Adjustable Height Arm	707	724	744	776	818	886	997	1092	1188	1282
		-39A8	●	Swing-Back Adjustable Height Arm	733	750	770	802	844	912	1023	1118	1214	1308
		-22A8	●	Adjustable Height Black	772	788	808	840	883	951	1062	1156	1252	1347
		-23A8	●	Adjustable Height Chrome	772	788	808	840	883	951	1062	1156	1252	1347

*-13C For Seat Slider, Replace -12C with -13C Add \$73 List How to Specify: **2R12-13C-39A8**

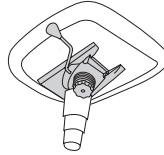

MID BACK MESH / STANDARD (A) SEAT - Syncro Control (WEIGHT CAPACITY 300 LBS)

MODEL	CONTROL	ARM	QS	DESCRIPTION (SEE BELOW)	A	B	1/COM	2	3/COL	4	5	6	7	8
2R12	-60C	-0A	●	No Arms	629	646	666	698	740	808	919	1014	1110	1204
		-38A8	●	Adjustable Height Arm	707	724	744	776	818	886	997	1092	1188	1282
		-39A8	●	Swing-Back Adjustable Height Arm	733	750	770	802	844	912	1023	1118	1214	1308
		-22A8	●	Adjustable Height Black	772	788	808	840	883	951	1062	1156	1252	1347
		-23A8	●	Adjustable Height Chrome	772	788	808	840	883	951	1062	1156	1252	1347

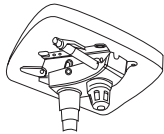

MID BACK MESH / STANDARD (A) SEAT - Syncro Control with Side Tension Adjustment (WEIGHT CAPACITY 300 LBS)

MODEL	CONTROL	ARM	QS	DESCRIPTION (SEE BELOW)	A	B	1/COM	2	3/COL	4	5	6	7	8
2R12	-9C	-0A	●	No Arms	681	698	718	750	792	860	971	1066	1162	1256
		-38A8	●	Adjustable Height Arm	759	776	796	828	870	938	1049	1144	1240	1334
		-39A8	●	Swing-Back Adjustable Height Arm	785	802	822	854	896	964	1075	1170	1266	1360
		-22A8	●	Adjustable Height Black	824	840	860	892	935	1003	1114	1208	1304	1399
		-23A8	●	Adjustable Height Chrome	824	840	860	892	935	1003	1114	1208	1304	1399

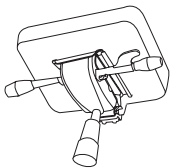

STANDARD ARM OPTIONS

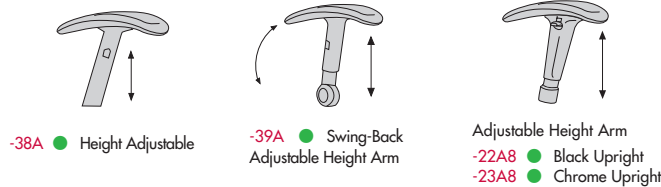

How to Specify:



STANDARD CHAIR OPTIONS

SUFFIX	QS DESCRIPTION	PRICE
-9	● Four Way Adjustable Arm Cap (22A, 23A)	\$31 List
-155C	● Hard Floor Casters	\$23 List
-15GL	● Glides	\$23 List
-15XC	● Spoked Casters	\$33 List
-11PB	● Polished Aluminum Base	\$92 List
-11BA	● Brushed Aluminum Base	\$92 List
-14AB	● Adj. Width Bracket (22A, 23A only)	\$23 List
-11CB	○ Custom Stain Base (5 chair minimum)	\$223 List
-21TB133	○ Fire Rated Products (see page 11)	\$92 List
-305S	● Seat Slide (9C only)	\$73 List
-11DR	● Drafting Stool kit - footing	\$126 List

MESH COLORS AVAILABLE

SUFFIX	QS DESCRIPTION	PRICE
-01-HM	● Black Mesh	\$0 List
-03-HM	● Graphite Mesh	\$21 List
-05-HM	● Doe Mesh	\$21 List
-07-HM	● Sea Foam Mesh	\$21 List

VOSS

GUEST SEATING

MID MESH BACK / MID UPHOLSTERED BACK

True 48-Hour Commitment

- **20/48** 20 Chairs Every 48 Hours (Selected Models & Options Only)
- **10/48** 10 Chairs Every 48 Hours (Selected Models & Options Only)

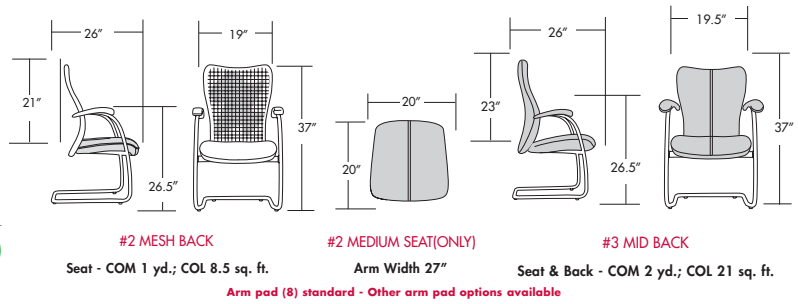

MID MESH BACK - Side Chair / Medium Seat / Mesh Back (WEIGHT CAPACITY 300 LBS)

MODEL	ARM	QS	DESCRIPTION (SEE BELOW)	A	B	1/COM	2	3/COL	4	5	6	7	8
2V22	-24SB8	●	Black Sled Base	759	770	782	802	829	876	939	998	1057	1116
	-24SC8	●	Chrome Sled Base	821	832	844	864	891	938	1001	1060	1119	1178

MESH COLORS AVAILABLE

SUFFIX	QS	DESCRIPTION	PRICE
-01-MM	●	Black Mesh	\$0 List
-03-MM	●	Graphite Mesh	\$21 List
-05-MM	●	Doe Mesh	\$21 List
-07-MM	●	Sea Foam Mesh	\$21 List

How to Specify: **2V22-24SB8**
 SEAT & BACK |
 BASE

MID UPHOLSTERED BACK - Side Chair / Medium Seat / Upholstered Back (WEIGHT CAPACITY 300 LBS)

MODEL	ARM	QS	DESCRIPTION (SEE BELOW)	A	B	1/COM	2	3/COL	4	5	6	7	8
2V23	-24SB8	●	Black Sled Base	815	832	853	886	931	1010	1115	1213	1311	1409
	-24SC8	●	Chrome Sled Base	877	894	915	948	993	1072	1177	1275	1373	1471

How to Specify: **2V23-24SB8**
 SEAT & BACK |
 BASE

STANDARD CHAIR OPTIONS

SUFFIX	QS	DESCRIPTION	PRICE
-21TB133	●	Fire Rated Products (see page 11)	\$92 List